

ADDENDUM NO. 1
TO
PROCUREMENT AND CONTRACTING REQUIREMENTS
FOR
Milton Drinking Water System Improvements
FOR
MILTON, INDIANA
Issue Date: February 14th, 2025

BIDS ARE DUE BY
February 19th, 2025
12:00 PM (Local Time)
Attn. Clerk Treasurer, Amy Smith – 101 SR-1 Milton, IN 47357

This addendum consists of four (4) pages and the following attachments:

- Attachment No. 1:** Pre-Bid Conference Meeting Minutes and Sign-In Sheet
- Attachment No. 2:** Updated Specifications and Bulk Filling Station Info
- Attachment No. 3:** Latest Wage Determination Info (DBA)

The following, as additions to and modifications in the Bidding Requirements and Contract Documents, will be included in, and become a part of the **Milton Drinking Water System Improvements FY25** This Addendum forms a part of the Contract Documents. Bidders are, therefore, instructed to take the following into account in rendering any Bid for this work. Acknowledge receipt of this Addendum in the space provided on the Bid Form.

CHANGES TO PRIOR ADDENDA: (N/A)

CHANGES TO PROCUREMENT REQUIREMENTS: (N/A)

CHANGES TO CONTRACTING REQUIREMENTS: (N/A)

CHANGES TO SPECIFICATIONS:

1. **PLEASE NOTE:** *“Or equal” items will be considered for all products, including products not explicitly stated. We acknowledge that lead times are volatile and that certain product types may be more readily available or cost effective. If exceptions are needed to standards, they will be considered for approval on a case-by-case basis.*
2. Replace the following specifications in their entirety with **Attachment No. 2** of this addendum:
 - a. “Specification 00 41 13 – Bid Form” (Updated improperly calculated 8” pipe and HDPE casing amounts.)
 - b. “Specification 01 20 00 – Contract Items” (Adjusted all HDPE casing from DR-17 to DR-11, see note.)

NOTE: SEE PAGE 16!

CHANGES TO DRAWINGS: (N/A)

- 1. NOTE: DR for HDPE Casing throughout the project will now be DR-11 rather than DR-17 as indicated on the plans. In lieu of a new set being distributed, the specifications have been updated. Please keep this in mind.**

CHANGES TO MISCELLANEOUS DOCUMENTS:

- Included as an attachment to this addendum (**Attachment No. 1**) is the Pre-Bid Conference Meeting Minutes and Sign-In Sheet.

SUBMITTED QUESTIONS/REQUESTS & RESPONSES:

- Contractor Questions (Pre-Bid; Lykins and Miller Pipeline)**
 - Q:** For hydrants not attached to the new line, how is the contractor expected to replace them?
A: Attach via tee to existing main with new lead line and valve for complete assembly.
 - Q:** Do hydrant line items include the need for line stops?
A: No.
 - Q:** Are spacers required for all HDPE casings?
A: Yes, IDEM will require spacers in casings for these applications.
 - Q:** Are reconnects to existing service lines to the pit or just reconnects at the main?
A: These reconnects are to be done at the new main. The only true service line replacements will occur on the listed lead/galvanized service locations in contract.
 - Q:** Will the contractor have access to the ballpark for that easement?
A: Yes. There are two entry points with gates that will be opened.
 - Q:** Will cut in valves require line stops or will we be able to shut off the main?
A: We are not sure, but will attempt to shut off the main. It is likely line stops will be needed for the cut-in valves.
 - Q:** What size is the Water Main coming from the Milton Pump House?
A: 8"
 - Q:** Please clarify the extents of the LSLR work on service lines?
A: Where service lines are attached to replaced main, the lead or galvanized line should be replaced from the main to the premise plumbing of the home. For service lines attached to old main, the replacement will occur from the meter put to the home.
 - Q:** What is the breakdown of hydrants attached to new mains vs. old mains?
A: Approximately 26 hydrants attached to "new" main from 2023-2025 and the rest to "old" main.
 - Q:** What is the breakdown of LSLRs happening on new mains vs. old mains?
A: Approximately 43 services attached to "new" main from 2023-2025 and the rest to "old" main.
- Contractor Questions (Watson Excavation)**
 - Q:** Is there a need to open cut any areas and is installation procedure optional?
A: Installation procedure is optional based on contractor preference. We assume most will wish to HDD; in order to install drill pits, bends, and connections to existing main there would obviously require some small amounts of open-cut.
 - Q:** Is Certa Lok pipe acceptable?
A: We ask that all contractors bid based upon the same items described in the contract items (which is HDPE pipe). If the selected contractor finds that a different pipe type

(like C900 Certa Lok) would be more cost effective, they may provide this information upon their selection as a value add.

- c. **Q:** Will the Town supply water for Directional Drilling / Hydro Excavation?
A: Yes; contractors may use system water. (Example: from hydrant).
- d. **Q:** Will a dump site be provided for spoils and drill slurry?
A: Staging and storage can be done at the town-owned area near the ballpark as well as in the empty lot adjacent to the volunteer fire department; HOWEVER, spoils may not be left in these areas after the project is complete.
- e. **Q:** Are the service lines 1 inch or $\frac{3}{4}$ inch?
A: Almost exclusively $\frac{3}{4}$ ".
- f. **Q:** Is a curb stop required?
A: For reconnection of service lines, a curb stop is not required (see information in Q/A 1d.)
- g. **Q:** Does service line connection come before the meter pit or on the customer side?
A: For service line connections, these will come from the new main to the existing service line. For Lead Service Line Replacements, there is a separate contract item which includes replacing the entire lead or galvanized portion of the service line (but not the meter pit).
- h. **Q:** What is the termination point for Lead Service Line Replacement (Line Item #14)
A: Premise plumbing; which SRF defines as to the first shut-off valve inside of the home or 3' into the home. If it is not possible to replace to this point due to the specific makeup of a particular home, this can be waived on a home-by-home basis by SRF.
- i. **Q:** Will additional lead-specific water sampling be required for Line Item #14.
A: No.
- j. **Q:** Are there a size and count for cut and caps? Should line stops be included in the assumed cost or will water lines be able to be shut down by existing valves.
A: As shown on drawings for sizing and count. All attempts will be made to shut water lines down for connections. Note that while for hydrants the contractor should not include the cost of line stops, for connections to existing mains all reasonable assumptions should be made.
- k. **Q:** On RR bores, on the existing water lines to be grouted do you have distance and size?
A: Sizes are as indicated on the plans. Distance for grouting shall be under the full extent of the RR ROW, as shown on the plans.
- l. **Q:** Is a field office required?
A: No. Contractor means and methods.
- m. **Q:** Does the Town have a lot for storage?
A: Yes. Volunteer Fire Dept has an empty lot (which is under surveillance) as well as area near baseball fields at the end of Cherry St. owned by the Town.
- n. **Q:** Please provide all information on the Bulk Filling Station for pricing of the complete installation?
A: Bulk Filling Station (BFS) was purchased during the previous project and will be installed with this one. The BFS is an EleMech PortALogic station. The cut sheets and user information is provided in attachment.
- o. **Q:** Do you have any contacts for pipe bursting pricing, as we have no contacts to get pricing for this?
A: Many plumbing contractors specialize in this type of install if you have a plumbing contact.

+ + END OF ADDENDUM + +

PLEASE ACKNOWLEDGE THIS ADDENDUM IN THE BID FORM YOU SUBMIT.

Certified: *Whitney Henderson*
Engineer

Date: 02/14/2025

**ATTACHMENT 1:
PRE-BID MEETING
INFORMATION**

PRE-BID MEETING

Client: Town of Milton

Project Name: Milton Drinking Water Improvements Project

Project ID: 22-400-230-1

Meeting Location: Milton Municipal Building – 101 Central Ave., Milton, Indiana

Date: February 10th, 2025

Goals

- Introductions
- Scope of Work
- Document Availability
- Contract Milestones
- Addenda
- Special Considerations
- General Questions/Discussion

Introductions

- Town
- RQAW
- Contractors Present
- Sign-in Sheet

Scope of Work

- FY2025 Milton DW System Improvements
 - Over 2 miles total 6 and 8 inch WM with valving as shown.
 - Replace all hydrants (and add 2 new)
 - Service reconnections
 - Bulk water filling station installment
 - LSLRs

Document Availability

- RQAW Online Plan Room
 - Electronic documents can be downloaded for free from: <https://rqaw.com/public-documents/>

Milestone	Date
Pre-bid Meeting	February 10 th 2025
Last Day for Questions	February 13 th 2025
Final Addendum	February 17th 2025
Open Bids	February 19 th 2025
Close of SRF Loan	April/May 2025
Anticipated Notice to Proceed	April/May 2025

Bid Overview

- Bids Due – **February 19th at Noon**
 - Bid Location – Sealed bids submitted to the attention of the Clerk Treasurer at the Town of Milton, 101 Central Ave (SR-1), Milton, IN 47357
 - Bid Opening will occur at 12:00 PM at the Milton Municipal Building (101 Central Ave. (SR-1), Milton, Indiana 47357)
- Contract
 - Unit Price Contract
- Documents due at Bid
 - Completed Bid Form – Section 00 41 13
 - Required Bid Security
 - List of Proposed:
 - Subcontractors
 - Suppliers
 - List of Project References
 - Evidence of Bidder’s Authority to do business in the State of Indiana
 - Bidder’s state or contractor license number
 - Acknowledgement of Addendum(s)
 - Contractor’s Bid for Public Work – Form 96
 - Wage/Fringe Benefit Certification
 - BABA
 - Form OEE-1
 - Form OEE-2
 - Good Faith Efforts Worksheet
 - E-Verify Affidavit
 - Bids remain in effect for 90 days, but NTP and award should happen sooner.

Contract Milestones

- Substantial Completion –390 days

- Final Completion – 420 days
- Liquidated Damages: \$1,500 per day for missing Substantial Completion. \$750 per day for missing Final Completion.

Addenda

- All questions to be sent in writing to Whitney Weidenbenner no later than Thursday February 13th 2025:
 - Email: wweidenbenner@dccm.com
- Addendum No. 1
 - Issued ASAP.
 - Updates
 - HDPE Casing will be DR-11 vs DR-17
 - Any Clarifications on Plans as discussed today
 - Q/As

General Questions/Discussion

- Funding by SRF loan.
- IDEM, Norfolk Southern, and INDOT ROW permits have been submitted and are in process or already obtained.
 - IDEM and NS: agreements/approvals obtained.
 - CSGP: approval obtained.
 - INDOT ROW: in process (settlement monitoring plan required)
- Utility locations will need to be confirmed in the field.
- Potential Staging Areas – Volunteer Fire Dept
- Site Tours
 - A site tour will be conducted immediately after the Pre-Bid Meeting as requested.
 - All other site tours need to be coordinated individually with Amy Smith at (765) 478-3818.

**ATTACHMENT 2:
UPDATED
SPECIFICATIONS
AND BULK FILLING
STATION INFO**

BID FORM

Town of Milton, Indiana

Milton Drinking Water System Improvements

TABLE OF CONTENTS

	Page
ARTICLE 1 – Bid Recipient	1
ARTICLE 2 – Bidder’s Acknowledgements.....	1
ARTICLE 3 – Bidder’s Representations	1
ARTICLE 4 – Bidder’s Certification.....	2
ARTICLE 5 – Basis of Bid	3
ARTICLE 6 – Time of Completion.....	4
ARTICLE 7 – Attachments to this Bid.....	4
ARTICLE 8 – Defined Terms.....	2
ARTICLE 9 – Bid Submittal	6

ARTICLE 1 – BID RECIPIENT

1.01 This Bid is submitted to:

Town of Milton

101 SR-1

Milton, IN 47357

1.02 The undersigned Bidder proposes and agrees, if this Bid is accepted, to enter into an Agreement with Owner in the form included in the Bidding Documents to perform all Work as specified or indicated in the Bidding Documents for the prices and within the times indicated in this Bid and in accordance with the other terms and conditions of the Bidding Documents.

ARTICLE 2 – BIDDER’S ACKNOWLEDGEMENTS

2.01 Bidder accepts all of the terms and conditions of the Instructions to Bidders, including without limitation those dealing with the disposition of Bid security. This Bid will remain subject to acceptance for 90 days after the Bid opening, or for such longer period of time that Bidder may agree to in writing upon request of Owner.

ARTICLE 3 – BIDDER’S REPRESENTATIONS

3.01 In submitting this Bid, Bidder represents that:

A. Bidder has examined and carefully studied the Bidding Documents, and any data and reference items identified in the Bidding Documents, and hereby acknowledges receipt of the following Addenda:

<u>Addendum No.</u>	<u>Addendum, Date</u>
_____	_____
_____	_____
_____	_____
_____	_____

B. Bidder has visited the Site, conducted a thorough, alert visual examination of the Site and adjacent areas, and become familiar with and satisfied itself as to the general, local, and Site conditions that may affect cost, progress, and performance of the Work.

C. Bidder is familiar with and has satisfied itself as to all Laws and Regulations that may affect cost, progress, and performance of the Work.

D. Bidder has carefully studied all: (1) reports of explorations and tests of subsurface conditions at or adjacent to the Site and all drawings of physical conditions relating to existing surface or subsurface structures at the Site that have been identified in the Supplementary Conditions, especially with respect to Technical Data in such reports and drawings, and (2) reports and drawings relating to Hazardous Environmental Conditions, if any, at or adjacent to the Site that have been identified in the Supplementary Conditions, especially with respect to Technical Data in such reports and drawings.

- E. Bidder has considered the information known to Bidder itself; information commonly known to contractors doing business in the locality of the Site; information and observations obtained from visits to the Site; the Bidding Documents; and any Site-related reports and drawings identified in the Bidding Documents, with respect to the effect of such information, observations, and documents on (1) the cost, progress, and performance of the Work; (2) the means, methods, techniques, sequences, and procedures of construction to be employed by Bidder; and (3) Bidder's safety precautions and programs.
- F. Bidder agrees, based on the information and observations referred to in the preceding paragraph, that no further examinations, investigations, explorations, tests, studies, or data are necessary for the determination of this Bid for performance of the Work at the price bid and within the times required, and in accordance with the other terms and conditions of the Bidding Documents.
- G. Bidder is aware of the general nature of work to be performed by Owner and others at the Site that relates to the Work as indicated in the Bidding Documents.
- H. Bidder has given Engineer written notice of all conflicts, errors, ambiguities, or discrepancies that Bidder has discovered in the Bidding Documents, and confirms that the written resolution thereof by Engineer is acceptable to Bidder.
- I. The Bidding Documents are generally sufficient to indicate and convey understanding of all terms and conditions for the performance and furnishing of the Work.
- J. The submission of this Bid constitutes an incontrovertible representation by Bidder that Bidder has complied with every requirement of this Article, and that without exception the Bid and all prices in the Bid are premised upon performing and furnishing the Work required by the Bidding Documents.

ARTICLE 4 – BIDDER'S CERTIFICATION

4.01 Bidder certifies that:

- A. This Bid is genuine and not made in the interest of or on behalf of any undisclosed individual or entity and is not submitted in conformity with any collusive agreement or rules of any group, association, organization, or corporation;
- B. Bidder has not directly or indirectly induced or solicited any other Bidder to submit a false or sham Bid;
- C. Bidder has not solicited or induced any individual or entity to refrain from bidding; and
- D. Bidder has not engaged in corrupt, fraudulent, collusive, or coercive practices in competing for the Contract. For the purposes of this Paragraph 4.01.D:
 - 1. "corrupt practice" means the offering, giving, receiving, or soliciting of any thing of value likely to influence the action of a public official in the bidding process;
 - 2. "fraudulent practice" means an intentional misrepresentation of facts made (a) to influence the bidding process to the detriment of Owner, (b) to establish bid prices at artificial non-competitive levels, or (c) to deprive Owner of the benefits of free and open competition;
 - 3. "collusive practice" means a scheme or arrangement between two or more Bidders, with or without the knowledge of Owner, a purpose of which is to establish bid prices at artificial, non-competitive levels; and

4. "coercive practice" means harming or threatening to harm, directly or indirectly, persons or their property to influence their participation in the bidding process or affect the execution of the Contract.

ARTICLE 5 – BASIS OF BID

5.01 Bidder will complete the Work in accordance with the Contract Documents for the following price(s):

Item No.	Description	Unit	Estimated Quantity	Unit Price	Total Line Item Price
1	Mobilization and Demobilization	LS	1	\$	\$
2	Maintenance of Traffic	LS	1	\$	\$
3	Construction Engineering	LS	1	\$	\$
4	Erosion and Sediment Control	LS	1	\$	\$
5	Allowance to Replace Meter Pit and Meter Setters, Complete	ALLOW			\$54,000.00
6	6-Inch Water Main, DR 17 HDPE	LF	4,400	\$	\$
7	8-Inch Water Main, DR 17 HDPE	LF	5,600	\$	\$
8	HDPE Casing	LF	1,400	\$	\$
9	Steel Casing - Railroad	LF	440	\$	\$
10	Replace Fire Hydrant, Complete	EA	35	\$	\$
11	Reconnect Water Service, Complete	EA	80	\$	\$
12	Site Restoration	LS	1	\$	\$
13	Bulk Water Filling Station	LS	1	\$	\$
14	Lead Service Line Replacement, Complete	EA	69	\$	\$

Total Base Bid Price \$ _____

BID ALTERNATE

Item No.	Description	Unit	Estimated Quantity	Unit Add or Deduct	Total Add or Deduct (Write-In)
1	Change Installation Method from Pipe Bursting to Contractor Selection	LF	755	\$	\$

Total Base Bid Price – Bid Alternate

\$ _____

Proposed increase or decrease in price for the Bid Alternates listed above will be considered in determination of the lowest responsive and responsible bid.

The undersigned understands that after a contract is awarded, the Owner may select items of the Alternate Bids listed above. If awarded the contract, the Bidder agrees to furnish and install any Owner selected Alternate items for the add or deduct indicated. The total base bid will then be adjusted accordingly. The add or deduct amounts listed above are “installed” prices and take into consideration and include any cost of the design or construction changes that may be required as a result of selecting the Alternate.

Alternate Contract Item prices are subject to acceptance by the Owner, and rejection of one or more Alternate Contract Item prices will not invalidate acceptance of this Bid.

ARTICLE 6 – TIME OF COMPLETION

- 6.01 Bidder agrees that the Work will be substantially complete and will be completed and ready for final payment in accordance with Paragraph 15.06 of the General Conditions on or before the dates or within the number of calendar days indicated in the Agreement.
- 6.02 Bidder accepts the provisions of the Agreement as to liquidated damages.

ARTICLE 7 – ATTACHMENTS TO THIS BID

- 7.01 The following documents are submitted with and made a condition of this Bid:
- A. Required Bid security;
 - B. List of Proposed Subcontractors;
 - C. List of Proposed Suppliers;
 - D. List of Project References;
 - E. Bidder’s License No.: _____ demonstrating evidence of authority to do business in the state of Indiana.
 - F. Required Bidder Qualification Statement (Form 96) with supporting data;
 - G. Wage/Fringe Benefit Certification;
 - H. Build America Buy America;
 - I. Form OEE-1;
 - J. Form OEE-2;
 - K. Good Faith Efforts Worksheet;
 - L. E-Verify Affidavit

ARTICLE 8 – DEFINED TERMS

8.01 The terms used in this Bid with initial capital letters have the meanings stated in the Instructions to Bidders, the General Conditions, and the Supplementary Conditions.

ARTICLE 9 – BID SUBMITTAL

BIDDER: *[Indicate correct name of bidding entity]*

By:
[Signature] _____

[Printed name] _____
(If Bidder is a corporation, a limited liability company, a partnership, or a joint venture, attach evidence of authority to sign.)

Attest:
[Signature] _____

[Printed name] _____

Title: _____

Submittal Date: _____

Address for giving notices:

Telephone Number: _____

Fax Number: _____

Contact Name and e-mail address: _____

Bidder's License No.: _____
(where applicable)

SECTION 01 20 00 - CONTRACT ITEMS

PART 1 - GENERAL

1.1 DESCRIPTION

- A. The Section includes the Contract Items for the Project.

1.2 CONTRACT ITEM 1 – MOBILIZATION AND DEMOBILIZATION

A. Description: The Work under this Contract Item includes all work necessary for the movement of personnel and equipment to and from the project site. This shall include the submittal of a Performance Bond, Payment Bond, Maintenance Bond [SC-6.01], Contractor's Insurance for Worker's Compensation [SC-6.03], Contractor's Commercial General Liability [SC-6.03], Automobile Liability [SC-6.03], Excess or Umbrella Liability [SC-6.03], Contractor's Professional Liability [SC-6.03], Owner's Liability Insurance [SC-6.04], and Property Insurance [SC-6.05].

- B. Payment: Payment under Item 1 will be made at a Lump Sum Price.

1.3 CONTRACT ITEM 2 – MAINTENANCE OF TRAFFIC

A. Description: The Work under this Contract Item includes construction and maintenance of all detours, routing of traffic, and signage necessary to install the water main to the lines and slopes shown on the Drawings, and specified herein in addition to all other work required or incidental thereto.

- B. Payment: Payment under Item 2 will be made at a Lump Sum Price.

1.4 CONTRACT ITEM 3 – CONSTRUCTION ENGINEERING

A. Description: The Work under this Contract Item includes the planning and management of the project complete with all labor, material, and equipment necessary, including contractor's field office/trailer and INDOT Settlement Monitoring Plan for work done in INDOT Right of Way.

- B. Payment: Payment under Item 3 will be made at Lump Sum Price.

1.5 CONTRACT ITEM 4 – EROSION AND SEDIMENT CONTROL

A. Description: The Work under this Contract Item includes installing erosion and sediment control devices as shown on the Drawings and specified herein complete with all labor, material, and equipment necessary; along with maintaining and repairing/replacing these devices if determined necessary by the Engineer.

B. Payment: Payment under Item 4 will be made at a Lump Sum Price.

1.6 CONTRACT ITEM 5 – ALLOWANCE TO REPLACE METER PIT AND METER SETTER, COMPLETE

A. Description: The Work under this Contract Item includes (as necessary) installing meter pits and setters, and removal of existing meter pits as stated in the Drawings and specified herein, and all associated appurtenances, labor, material, and equipment as necessary for complete installation.

B. Payment: Payment under Item 5 will be made by allowance.

1.7 CONTRACT ITEM 6 – 6-INCH WATER MAIN, DR 17 HDPE

A. Description: The Work under this Contract Item includes clearing and grubbing, excavation, removal, and disposal of excavated materials as required, trench and excavation support, potholing, installing and backfilling the pipe, associated fittings, and joint restraints, all casings as depicted on drawings, and abandoning existing pipe as described, as well as connecting to existing services, complete with all labor, material, and equipment necessary to install the water main to the lines and slopes shown on the Drawings by the method stated on the drawings when indicated, and specified herein in addition to all other work required or incidental thereto.

B. Payment: Payment under Item 6 will be made for each linear foot of 6-inch DR 17 HDPE water main installed at the appropriate size and depth.

1.8 CONTRACT ITEM 7 – 8-INCH WATER MAIN, DR 17 HDPE

A. Description: T The Work under this Contract Item includes clearing and grubbing, excavation, removal, and disposal of excavated materials as required, trench and excavation support, potholing, installing and backfilling the pipe, associated fittings, and joint restraints, all casings as depicted on drawings, and abandoning existing pipe as described, as well as connecting to existing services, complete with all labor, material, and equipment necessary to install the water main to the lines and slopes shown on the Drawings by the method stated on the drawings when indicated, and specified herein in addition to all other work required or incidental thereto.

B. Payment: Payment under Item 7 will be made for each linear foot of 8-inch DR 17 HDPE water main installed at the appropriate size and depth.

1.9 CONTRACT ITEM 8 – HDPE CASING

- A. Description: The Work under this Contract Item includes all required work to install HDPE casing where indicated on the drawings and specified herein. **NOTE: Project documents are to be updated to HDPE DR-11 casing rather than DR-17 stated on drawings.**
- B. Payment: Payment under Item 8 will be made per linear foot of HDPE casing installed.

1.10 CONTRACT ITEM 9 – STEEL CASING - RAILROAD

- A. Description: The Work under this Contract Item includes all required work to install Steel casing where indicated on the drawings and specified herein.
- B. Payment: Payment under Item 9 will be made per linear foot of steel casing installed.

1.11 CONTRACT ITEM 10 – REPLACE FIRE HYDRANT, COMPLETE

- A. Description: The Work under this Contract Item includes replacing all hydrants in town with new hydrant assemblies in their entirety, up to the main line, along with proper testing. It also includes the installation of full hydrant assembly, connection and testing of new hydrants at the intersections of: E Connersville and River Road AND W Connersville and Cherry Street.
- B. Payment: Payment under Item 10 will be made for each hydrant.

1.12 CONTRACT ITEM 11 – RECONNECT WATER SERVICE, COMPLETE

- A. Description: The Work under this Contract Item includes the reconnection of all existing water service lines to the newly installed water main, for a complete working service line.
- B. Payment: Payment under Item 11 will be made for each address.

1.13 CONTRACT ITEM 12 – SITE RESTORATION

- A. Description: The Work under this Contract Item includes all restoration of grading, soils, asphalt, concrete, pavement markings, and all other items necessary to restore the project sites to their original condition, including but not limited to removal of existing pavements of all types, granular backfill, stone, HMA, and concrete.
- B. Payment: Payment under Item 12 will be made at a Lump Sum Price.

1.14 CONTRACT ITEM 13 – BULK WATER FILLING STATION

A. Description: The Work under this Contract Item includes installation, integration, and verification of a new bulk water non-potable filling station with proper signage and instructions across from the water treatment plant site as depicted in the drawings and specified herein, including all site work needed at this site.

B. Payment: Payment under Item 13 will be made at a Lump Sum Price.

1.15 CONTRACT ITEM 14 – LEAD SERVICE LINE REPLACEMENT, COMPLETE

A. Description: The Work under this Contract Item includes replacing existing water service lines from the meter pit to premise plumbing of homes per AWWA 810-17 standards and as dictated on the drawings from the water main tap to the structure, complete.

B. Payment: Payment under Item 14 will be made for each complete eligible service line replacement.

1.16 CONTRACT ITEM 15 – NON-MANDATORY BID ALTERNATE NO. 1 – CHANGE INSTALLATION METHOD FROM PIPE BURSTING TO CONTRACTOR SELECTION

A. Description: The Work under this Contract Item includes changing installation method to contractor preferred method in areas labeled for pipe bursting. Contractor installation must be constructible and may include open cut, directional drill, or other method as deemed appropriate. Payment will be made for each linear foot of pipe fully installed and in service along with all associated connections and fittings as indicated on the drawings.

B. Payment: Payment under Item 15 will be made per linear foot.

END OF SECTION 01 20 00



Control System Submittal

Project Name: Milton, IN

Customer: PortALogic

Specification: Bulk Water Station Control Panel - FS20

Job Number: PAL9542

Project Engineer: Joseph Wiseman

Date: 01-30-2024

Submittal ID: D9542

Revision: 0

SUBMITTAL	D9542
<input type="checkbox"/> APPROVED	<input type="checkbox"/> APPROVED AS NOTED
<input type="checkbox"/> REJECTED	<input type="checkbox"/> REVISE AND RESUBMIT
BY:	_____
DATE:	_____

EleMech INC
2275 White Oak Circle
Aurora, IL 60502
630-499-7080

Table of Contents



- A - Table of Contents
- B - Electrical Drawings
- C - Bill of Materials
- D - PortALogic User Manual



Rev: 0

Date: 01-30-2024

By: JJW

Section:

A

Job Number: PAL9542

Page # 1/1

Section Name: Table of Contents

Electrical Drawings



Rev:	0
Date:	01-30-2024
By:	JJW

Section:	B	
Job Number:	PAL9542	Page #
		1/1

Section Name:	Electrical Drawings
---------------	---------------------

MILTON DRINK WATER SYSTEM MILTON, IN	
PAL96542	
SPECIFICATION	BULK WATER FILL STATION
REFERENCE	123070-07

TABLE OF CONTENTS	
DESCRIPTION	DRAWING SHEET NO.
COVER PAGE	PAL9542A1
CONTROL PANEL SPECIFICATION	PAL9542A2
ELECTRICAL SCHEMATICS	PAL9542A3
FIELD WIRING DIAGRAM	PAL9542A5
DEVICE SETPOINTS	PAL9542A5
SEQUENCE OF OPERATION	PAL9542A5
ENCLOSURE LAYOUT	PAL9542A6
NAMEPLATE & LABEL DESCRIPTION	PAL9542A7

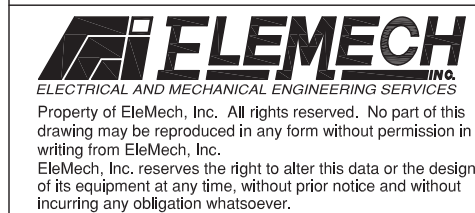

Preliminary Information Only
 For Approval Dimensions Certified

This drawing is limited to functional design, general arrangement and clearance. No responsibility is accepted by EleMech, Inc for other dimensions, quantities, or coordination with other equipment or drawings except as stated in the purchase order.

By _____ Date _____

REV	DESCRIPTION	BY	DATE

REFERENCE INFORMATION
 ELEMECH FILE: PAL9542A1

PROJECT NAME
 MILTON, IN
 I23070-70

DRAWN BY	DATE
JJW	01/26/24
CHECKED BY	DATE
BMG	01/26/24
SCALE	NONE

TITLE
 BULK WATER FILL STATION
 CONTROL PANEL
 FS-20

DRAWING NO. **PAL9542A1** REV **0**
 SHEET 1 OF 7

Control Panel Enclosure

Rating:	NEMA TYPE 4X		
Material:	304 SS		
Disconnect Type:	N/A		
<input checked="" type="checkbox"/> Dead Front	<input checked="" type="checkbox"/> 3-PT Latch	<input checked="" type="checkbox"/> Heater	<input type="checkbox"/>
<input type="checkbox"/>	<input type="checkbox"/>	<input type="checkbox"/>	<input type="checkbox"/>
Installation Conditions:	<input type="checkbox"/> Indoor - Unconditioned <input type="checkbox"/> Indoor - Conditioned <input type="checkbox"/> Outdoor - Direct Sunlight <input checked="" type="checkbox"/> Outdoor - Shaded		
Environment Max Temperature Rating (°F):	110		
Internal Device Max Temperature Rating (°F):	131		
Climate Control Type:	None Required		

Panel Construction

Certification:	UL508A		
Listing Serial Number:	TBD		
Options:	<input checked="" type="checkbox"/> UPS <input checked="" type="checkbox"/> Receptacle <input type="checkbox"/> <input type="checkbox"/> <input type="checkbox"/> <input type="checkbox"/> <input type="checkbox"/>		
Nameplates and Legendplates:	Material Type: Thermal Printed Attachment Type: Adhesive Colors: Background: White Text: Black		
Wire/ Cable Type:	Wire Color:	Wire Labels:	
Wiring to be 14 AWG unless otherwise specified. 16 AWG minimum. Wire shall be MTW type, tinned copper, 600VAC, 105°C, UL1015/CSA.	Black - Power Black - 120VAC Hot White - 120VAC Neutral Red - 120VAC Control Yellow - Foreign Voltage Green - Ground Blue - DC Positive White/Blue - DC Negative	<input checked="" type="checkbox"/> Adhesive, Self-laminating <input type="checkbox"/> Heat Shrink	
Ethernet cables shall be 24AWG rated 600V. Cat5e.	Note: Colors based on UL508A requirements.		

Local Enclosure

Tag:	N/A	Rating:	N/A	Material:	N/A
------	-----	---------	-----	-----------	-----

Power and Motor

Power Feed:					
Circuit 1 :	120	VAC	4.5	FLA	SCCR 5 KAIC @ 120 VAC
Motor Data:					
Motor 1 :	N/A	VAC	N/A	FLA	N/A HP Controller: N/A

Networking

Communication Type:	Ethernet/ IP	
Subnet:	255.255.255.0	Gateway: 192.168.2.1
IP Address:		
EBOX1	LAN2: 10.0.0.2	
EBOX1	LAN1: 192.168.2.2	
PR1:	10.0.0.3	
Programming:		
EBOX1	Hamsing	Software: Portalogic Version: 6.4.0.0
Notes:	1. PLC shall be programmed with ladder type only.	

Instrumentation

Tag:	N/A	Cable Length:	N/A
Rating:	<input type="checkbox"/> Non-Hazardous	<input type="checkbox"/> Intrinsically Safe Class 1 Division 1,2	
	<input type="checkbox"/> Class 1, Division 2	<input type="checkbox"/> Class 1 Division 1,2	



Preliminary Information Only
 For Approval Dimensions Certified
 This drawing is limited to functional design, general arrangement and clearance. No responsibility is accepted by EleMech, Inc for other dimensions, quantities, or coordination with other equipment or drawings except as stated in the purchase order.
 By _____ Date _____

REV	DESCRIPTION	BY	DATE

REFERENCE INFORMATION
 ELEMECH FILE: PAL9542A2

PROJECT NAME
 MILTON, IN
 I23070-70

DRAWN BY	DATE
JJW	01/26/24
CHECKED BY	DATE
BMG	01/26/24
SCALE	NONE

TITLE
 BULK WATER FILL STATION
 CONTROL PANEL
 FS-20
 DRAWING NO. PAL9542A2
 SHEET 2 OF 7
 REV 0

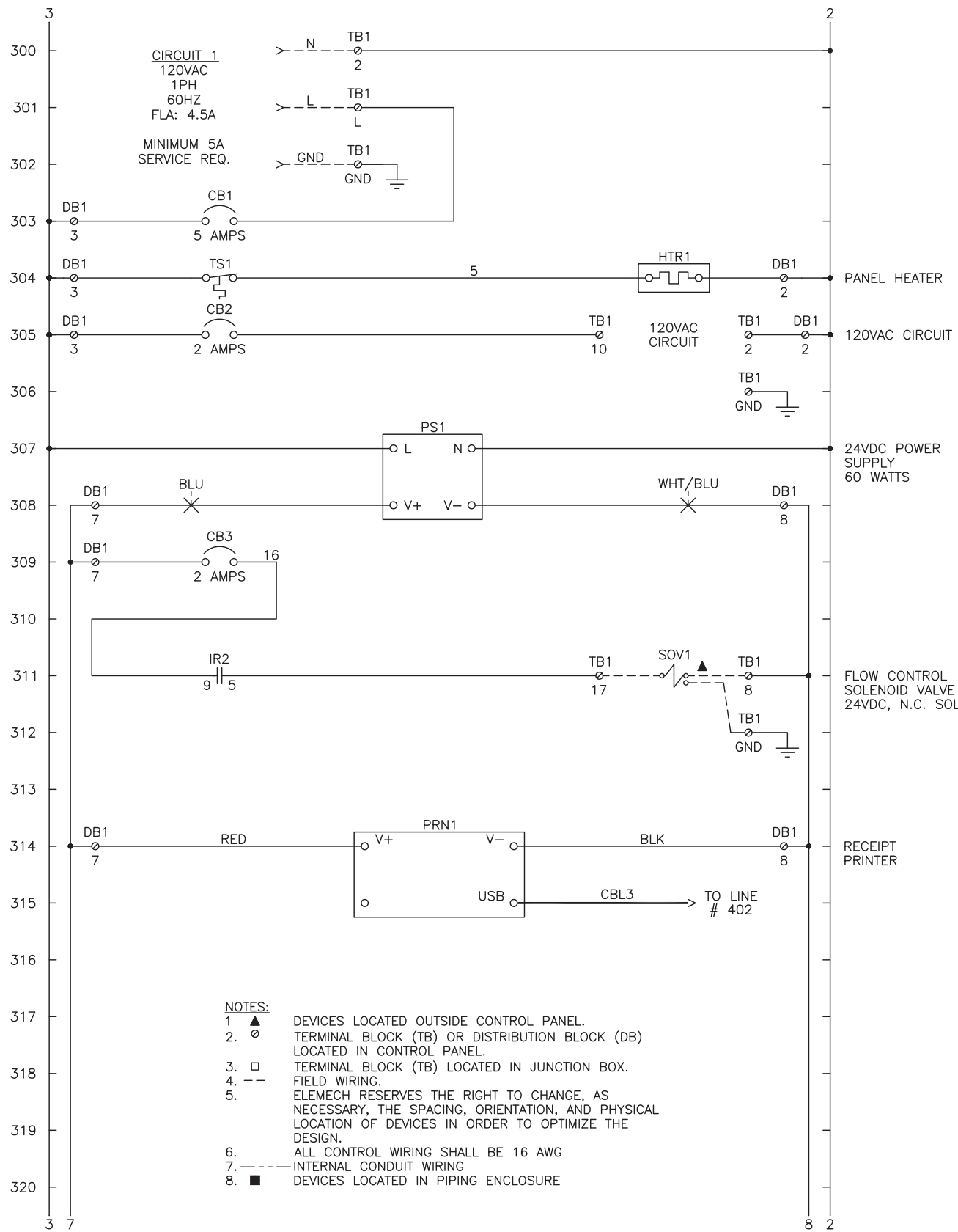

- NOTES:**
- ▲ DEVICES LOCATED OUTSIDE CONTROL PANEL.
 - TERMINAL BLOCK (TB) OR DISTRIBUTION BLOCK (DB) LOCATED IN CONTROL PANEL.
 - TERMINAL BLOCK (TB) LOCATED IN JUNCTION BOX.
 - FIELD WIRING.
 5. ELEMECH RESERVES THE RIGHT TO CHANGE, AS NECESSARY, THE SPACING, ORIENTATION, AND PHYSICAL LOCATION OF DEVICES IN ORDER TO OPTIMIZE THE DESIGN.
 6. ALL CONTROL WIRING SHALL BE 16 AWG
 7. --- INTERNAL CONDUIT WIRING
 8. ■ DEVICES LOCATED IN PIPING ENCLOSURE

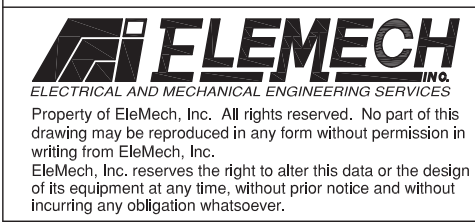
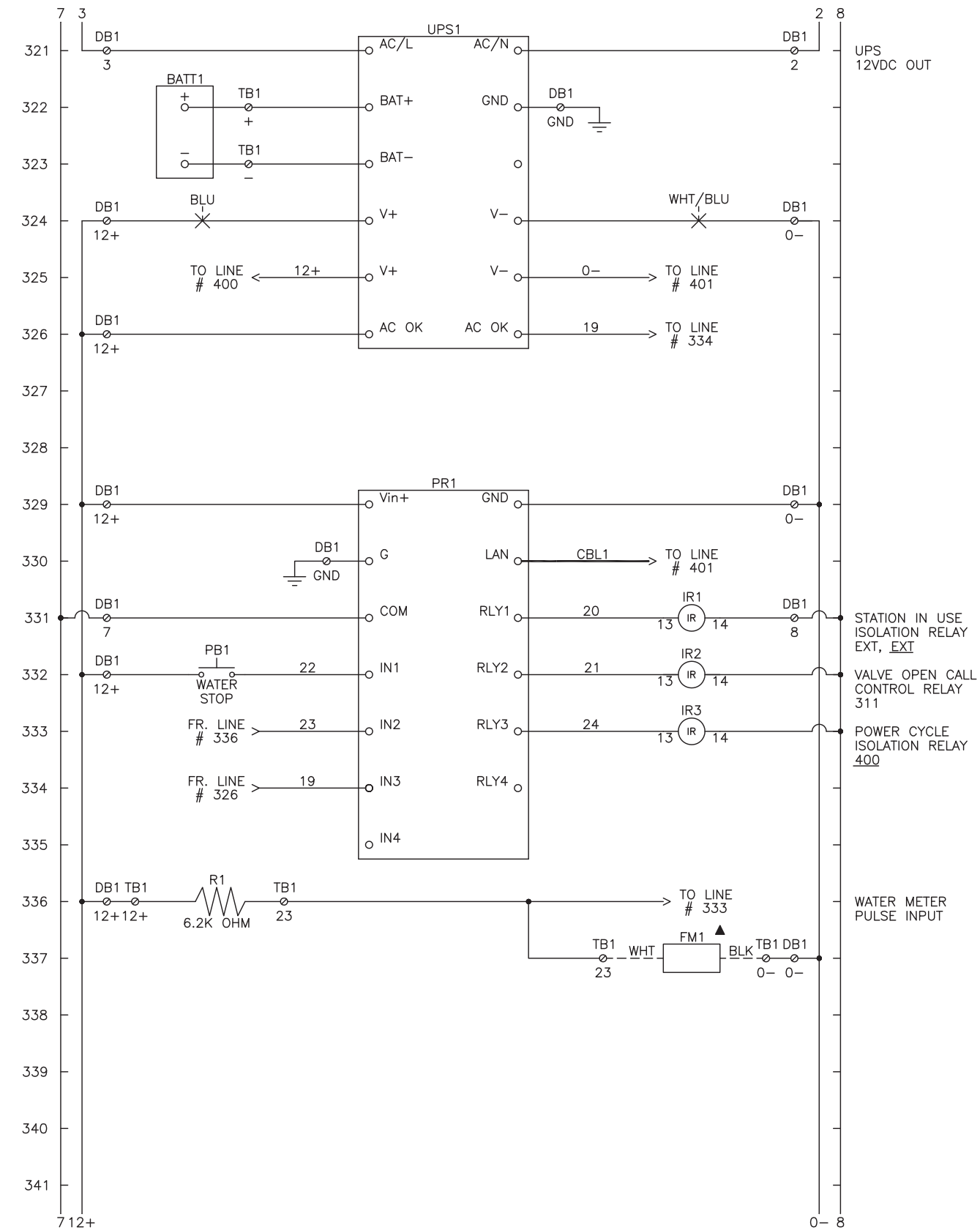

Preliminary Information Only
 For Approval Dimensions Certified

This drawing is limited to functional design, general arrangement and clearance. No responsibility is accepted by EleMech, Inc for other dimensions, quantities, or coordination with other equipment or drawings except as stated in the purchase order.

By _____ Date _____

REV	DESCRIPTION	BY	DATE

REFERENCE INFORMATION
ELEMECH FILE: PAL9542A3

PROJECT NAME
**MILTON, IN
I23070-70**

DRAWN BY
JJW

CHECKED BY
BMG

SCALE
NONE

TITLE
**BULK WATER FILL STATION
CONTROL PANEL
FS-20**

DRAWING NO.
PAL9542A3

REV
0

SHEET 3 OF 7

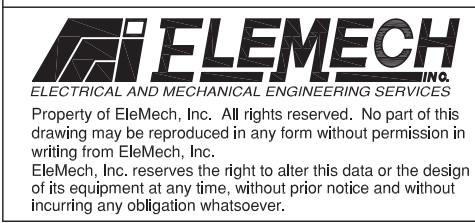
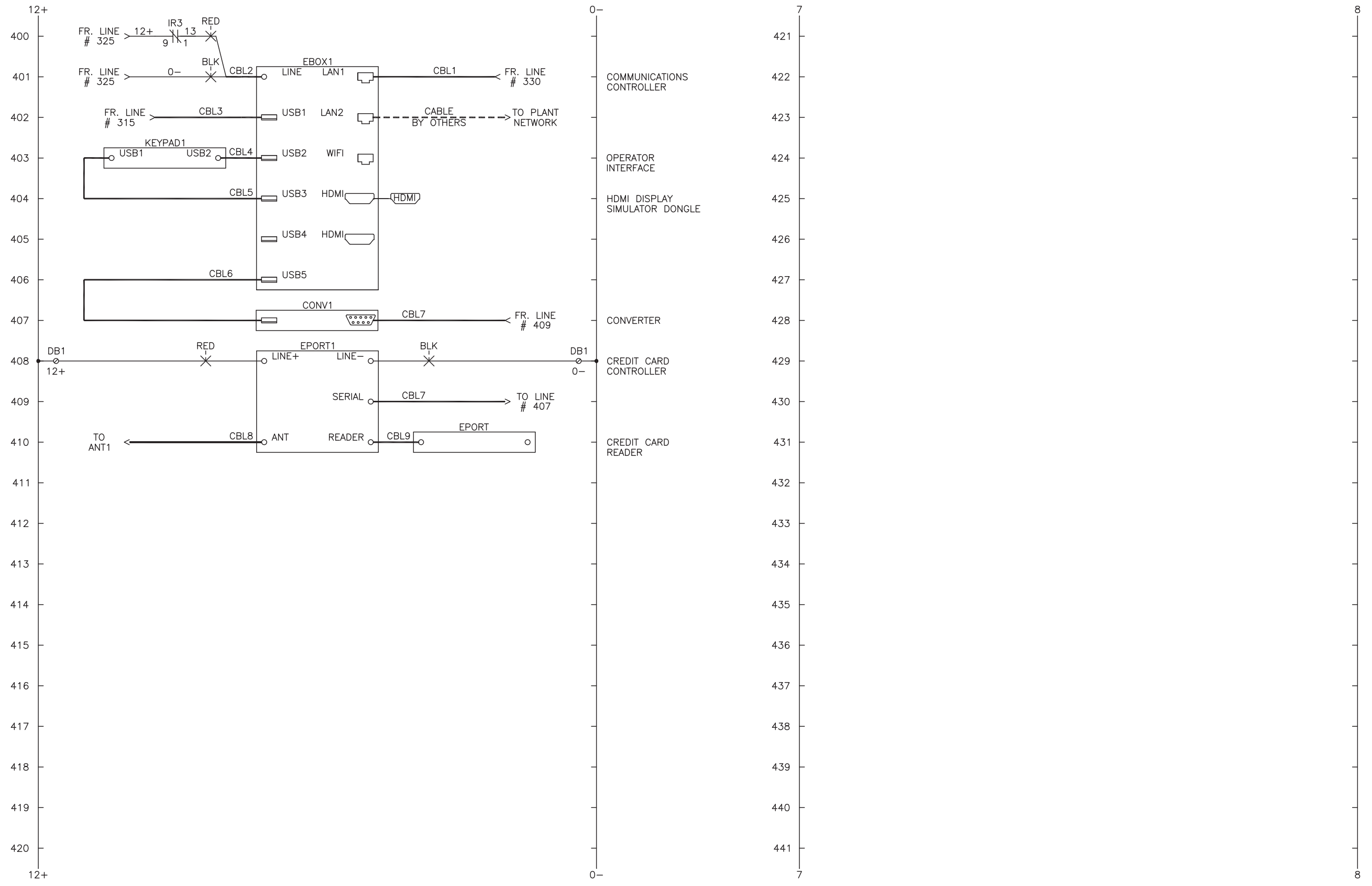

Preliminary Information Only
 For Approval Dimensions Certified

This drawing is limited to functional design, general arrangement and clearance. No responsibility is accepted by EleMech, Inc for other dimensions, quantities, or coordination with other equipment or drawings except as stated in the purchase order.

By _____ Date _____

REV	DESCRIPTION	BY	DATE

REFERENCE INFORMATION
ELEMECH FILE: PAL9542A4

PROJECT NAME
**MILTON, IN
 I23070-70**

DRAWN BY	DATE
JJW	01/26/24
CHECKED BY	DATE
BMG	01/26/24
SCALE	NONE

TITLE
**BULK WATER FILL STATION
 CONTROL PANEL
 FS-20**

DRAWING NO. **PAL9542A4** REV **0**
 SHEET 4 OF 7

FIELD WIRING DIAGRAM

WARNING:
 DAMAGE RESULTING FROM INSTALLATION OF TOP ENTRY CONDUIT WILL VOID WARRANTY
 - AVOID CUTTING HOLES DIRECTLY ABOVE ANY ELECTRICAL COMPONENTS
 - PROTECT INTERNAL COMPONENTS FROM METAL SHAVINGS, CUTTING OILS, DEBRIS, AND MOISTURE
 - USE PROPER FITTINGS, MYERS TYPE 4 OR EQUAL
 - CONDUIT AND FITTING MUST BE SEALED WATERTIGHT TO PREVENT WATER ENTRY
 - ALL PENETRATIONS MUST BE SEALED OFF TO PREVENT INTRUSION OF MOISTURE, CORROSIVE GASES, AND VAPORS FROM ENTERING THE ENCLOSURE

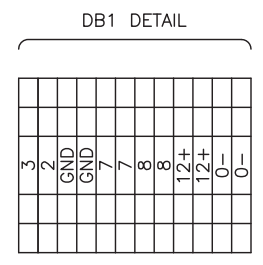
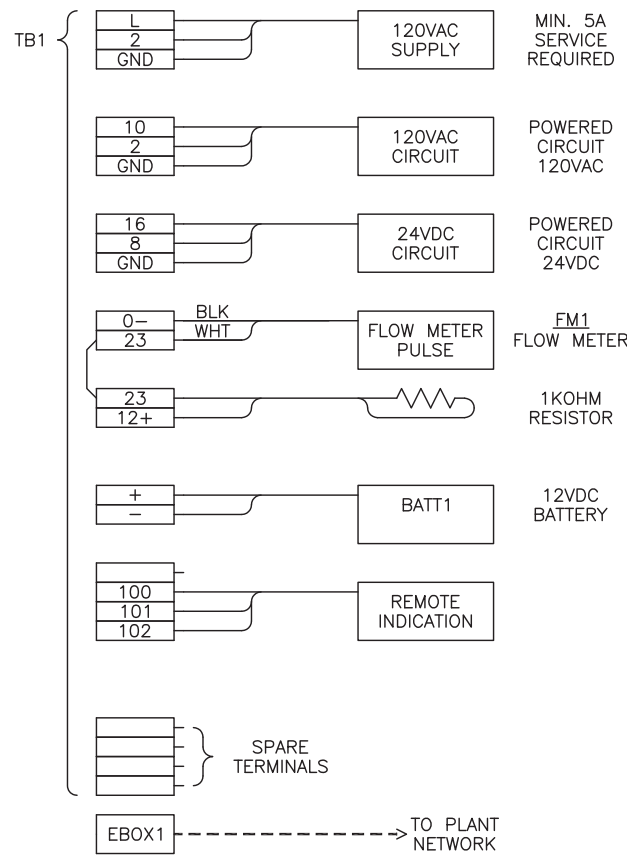

STATION INSTRUCTIONS:

- USER ACCESS WILL BE AUTHORIZED THROUGH THE PORTALOGIC SOFTWARE BY THE OWNER. ACCESS CODES WILL BE DISTRIBUTED TO THE USERS.
 - PORTALOGIC SOFTWARE TO BE INSTALLED ON A PLANT OWNED PC WITH NETWORK CONNECTIVITY TO THE STATION.
- USER SHALL PRESS **START** TO BEGIN.
 - USER SHALL SELECT METHOD OF PAYMENT (CREDIT CARD OR ACCESS NUMBER)
 - IF CREDIT CARD WAS SELECTED, THE USER MAY SWIPE THEIR CREDIT CARD TO BEGIN DISPENSING
 - IF ACCESS NUMBER WAS SELECTED, THE USER SHALL ENTER ACCESS NUMBER AND PRESS ENTER, THEN ENTER PIN AND PRESS **ENTER**.
 - SELECT MODE OF DISPENSING: 'AUTO FILL' OR 'MANUAL' AND PRESS **ENTER**.
 - IF 'AUTO FILL' WAS SELECTED, ENTER REQUIRED GALLONS AND PRESS **ENTER**.
 - IF 'MANUAL' WAS SELECTED, PROCEED TO STEP 3.
- THE DISPENSING SCREEN WILL APPEAR. PRESSING THE **START** BUTTON WILL CALL THE VALVE TO OPEN AND FLOW WILL BEGIN. TOTALIZED VOLUME WILL BE SHOWN ON THE DISPLAY.
 - FLOW MAY BE TEMPORARILY STOPPED BY PRESSING **STOP** OR THE WATER STOP PUSHBUTTON AT ANY TIME.
 - IF 'MANUAL' MODE WAS SELECTED, ALL OPERATION OF THE STATION WILL BE VIA THE **START** AND **STOP** BUTTONS.
 - 'MANUAL' MODE IS NOT ALLOWED FOR CREDIT CARD TRANSACTIONS.
 - THERE ARE NO REFUNDS FOR CREDIT CARD AT THE STATION.
- FLOW WILL CONTINUE UNTIL VOLUME REQUESTED EQUALS THE VOLUME DISPENSED, WHICH WILL END THE PROCESS.
- THE SYSTEM IS NOW READY TO PROCESS THE NEXT TRANSACTION.

POWER FAILURE
 IN THE EVENT OF AN AC POWER FAILURE, ANY TRANSACTION CURRENTLY IN PROGRESS WILL BE ENDED. WHILE THE AC POWER IS OUT, USERS MAY NOT LOG INTO THE STATION. IF POWER REMAINS OFF FOR AN EXTENDED PERIOD OF TIME, THE STATION WILL SHUT DOWN.
 THE STATION WILL AUTOMATICALLY POWER BACK ON, UPON AC POWER RETURNING.

DEVICE SETTINGS

IS1 - SETTINGS
 HEATER ON/OFF | 60 °F

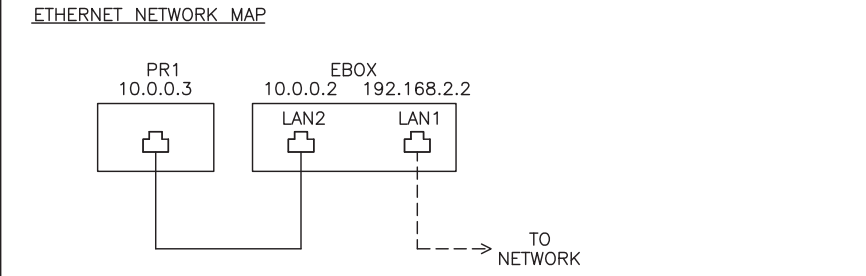

NOTES:
 1. --- CAT5 ETHERNET CABLE SUBNET MASK: 255.255.255.0

EPORT1 - INFORMATION

PARAMETER	VALUE
TELEMETER NO.	TBD
PASSCARD	TBD

DRY OUTPUT CONTACTS

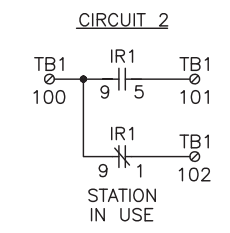

MAX. CONTROLLED LOAD: 10A @ 120VAC
 NOTE: BRANCH CIRCUIT PROTECTION PROVIDED BY OTHERS PER N.E.C.

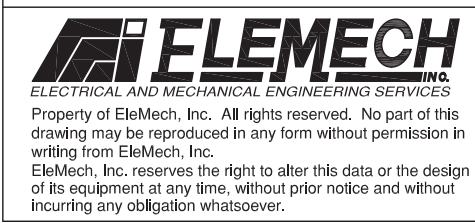

Preliminary Information Only
 For Approval Dimensions Certified
 This drawing is limited to functional design, general arrangement and clearance. No responsibility is accepted by EleMech, Inc for other dimensions, quantities, or coordination with other equipment or drawings except as stated in the purchase order.
 By _____ Date _____

REV	DESCRIPTION	BY	DATE

REFERENCE INFORMATION
ELEMECH FILE: PAL9542A5

PROJECT NAME
**MILTON, IN
 I23070-70**

DRAWN BY
JJW
 DATE
01/26/24
 CHECKED BY
BMG
 DATE
01/26/24
 SCALE
NONE

TITLE
**BULK WATER FILL STATION
 CONTROL PANEL
 FS-20**
 DRAWING NO.
PAL9542A5
 SHEET 5 OF 7
 REV
0

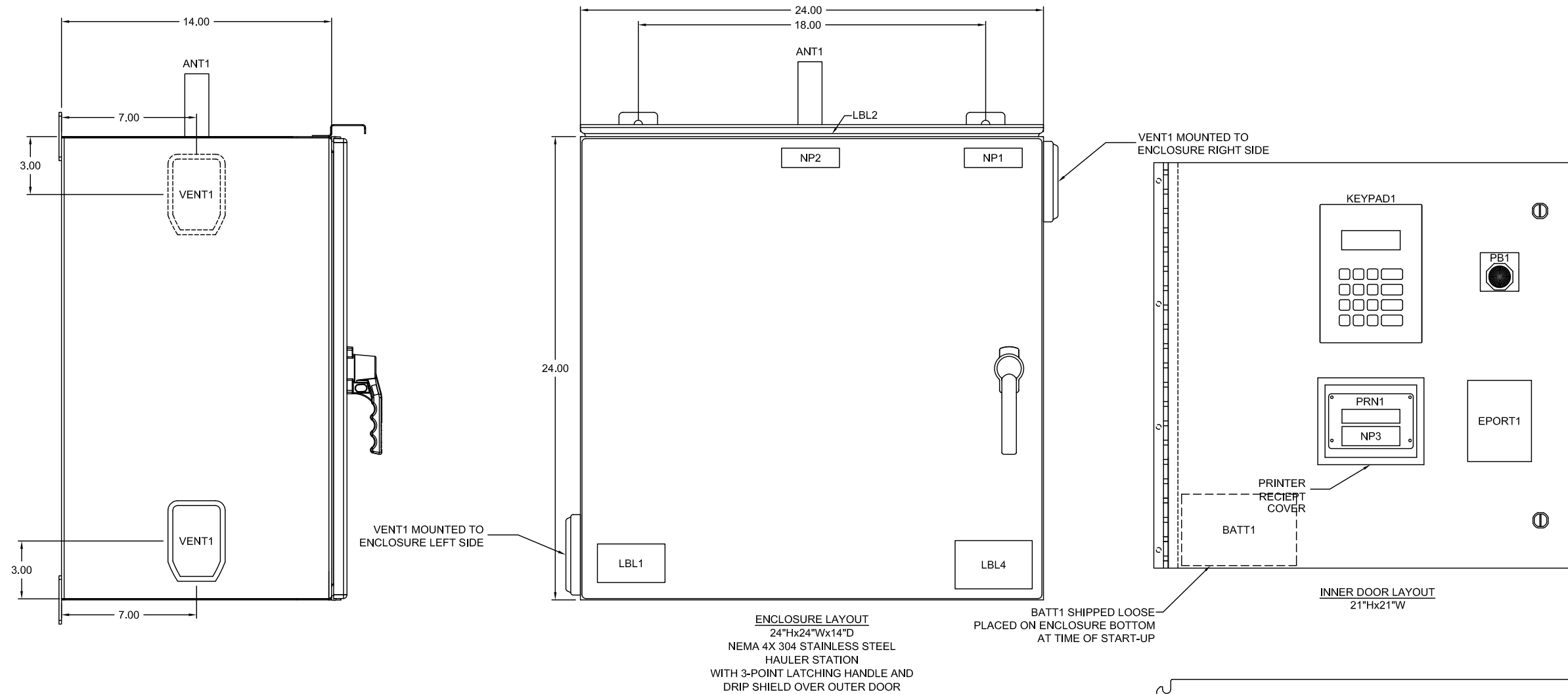

SHIPPED LOOSE ITEMS		
PART #	DEVICE TAG	MANUFACTURER PART #
101-564-001	SOV1	CLA-VAL: 3" 136-01-YKC
60-619-002	FM1	SENSUS: 3 C2 1G 17LL 8WHL

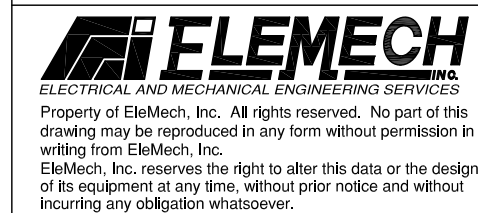
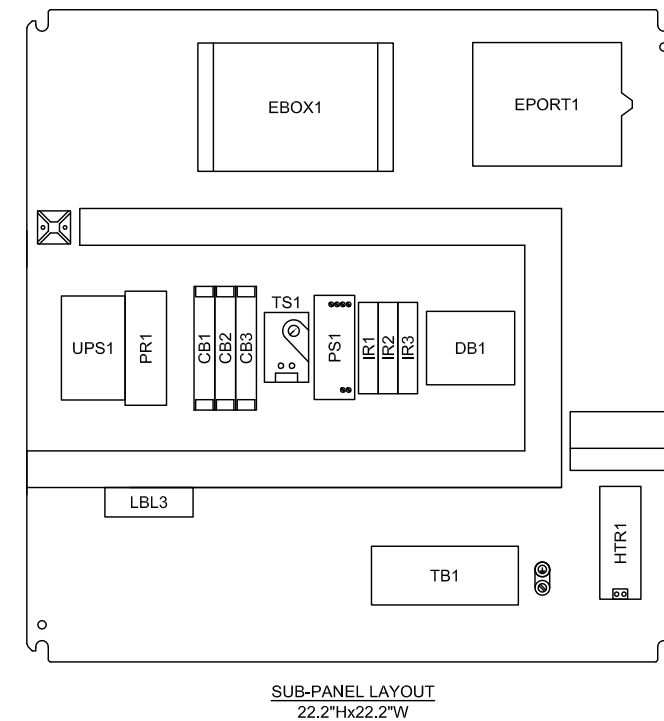

Preliminary Information Only
 For Approval Dimensions Certified

This drawing is limited to functional design, general arrangement and clearance. No responsibility is accepted by EleMech, Inc for other dimensions, quantities, or coordination with other equipment or drawings except as stated in the purchase order.

By _____ Date _____

REV	DESCRIPTION	BY	DATE

REFERENCE INFORMATION
ELEMECH FILE: PAL9542A6

PROJECT NAME
MILTON, IN
I23070-70

DRAWN BY
JJW

CHECKED BY
BMG

SCALE
NONE

TITLE
BULK WATER FILL STATION
CONTROL PANEL
FS-20

DRAWING NO.
PAL9542A6

REV
0

SHEET 6 OF 7

LEGENDPLATES			
TAG	DESCRIPTOR LINE 1	DESCRIPTOR LINE 2	DESCRIPTOR LINE 3
PB1	WATER	STOP	

NAMEPLATES			
TAG	DESCRIPTOR LINE 1	DESCRIPTOR LINE 2	DESCRIPTOR LINE 3
NP1	120VAC-1PH-60HZ		
NP2	BULK WATER	FILL STATION	

LABEL DESCRIPTION	
LBL1	ELEMECH ELECTRICAL CONTROL SYSTEMS
LBL2	WARNING DAMAGE RESULTING FROM INSTALLATION OF TOP ENTRY CONDUIT WILL VOID WARRANTY. - AVOID CUTTING HOLES DIRECTLY ABOVE ANY ELECTRICAL COMPONENTS - PROTECT INTERNAL COMPONENTS FROM METAL SHAVINGS, CUTTING OILS, DEBRIS, AND MOISTURE - USE PROPER FITTINGS, MYERS TYPE 4 OR EQUAL - CONDUITS AND FITTING MUST BE WATERTIGHT TO PREVENT WATER ENTRY - ALL PENETRATIONS MUST BE SEALED OFF TO PREVENT INTRUSION OF MOISTURE, CORROSIVE GASES, AND VAPORS FROM ENTERING THE ENCLOSURE
LBL3	CONNECT BATTERY TERMINALS AT TIME OF PANEL INSTALLATION
LBL4	WARNING UPS VOLTAGE PRESENT WHEN POWER IS OFF. CONTACT MAY CAUSE ELECTRICAL SHOCK OR BURN. TURN OFF AND LOCK-OUT UPS OUTPUT POWER BEFORE SERVICING.

NAMEPLATES AND LEGENDPLATES CONSTRUCTION			
	PANEL LEGENDPLATES	NAMEPLATES	DEVICE TAGS
TEXT COLOR	BLACK	BLACK	BLACK
BACKGROUND COLOR	WHITE/ YELLOW (E-STOPS)	WHITE	WHITE
MATERIAL	THERMAL TRANSFER	THERMAL TRANSFER	THERMAL TRANSFER
ATTACHMENT	ADHESIVE	ADHESIVE	ADHESIVE
TEXT SIZE	5/32" HIGH	3/16" HIGH	1/8" HIGH
DIMENSIONS	2.25"x2.25"	2.72"x1"	1"x1/2"
MAX. CHARACTERS PER LINE	15	17	7

PANEL DATA LABEL



ELEMECHINC.COM 630-499-7080

WARRANTY NOTICE
 NO ALLOWANCE OR PAYMENT WILL BE MADE FOR WARRANTY REPAIR UNLESS PRIOR AUTHORIZATION HAS BEEN REQUESTED AND OBTAINED FROM THE ELEMECH SERVICE DEPT.

SERIAL: PAL9542 POWER: 1/60/120
 REF: # I23070-70 FLA: 4.5 A
 DATE: TBD LGST MOT: N/A

SHORT CIRCUIT CURRENT RATING
 N/A KA RMS SYMMETRICAL @ N/A VOLTS MAX

ENCLOSURE RATING: NEMA TYPE 4X

NAME: MILTON, IN

TORQUE SCREWS TO 12 IN-LBS

ALL FIELD WIRING SHALL BE 60°C COPPER CONDUCTOR ONLY

CIRCUIT 2: 10A@120VAC

NOTE:
 THE CONTROL PANEL WILL ALSO BE LISTED AND LABELED WITH A SERIALIZED LABEL AS OUTLINED IN THE CONTROL PANEL SPECIFICATION NOTES.

PILOT DEVICE LEGENDPLATES

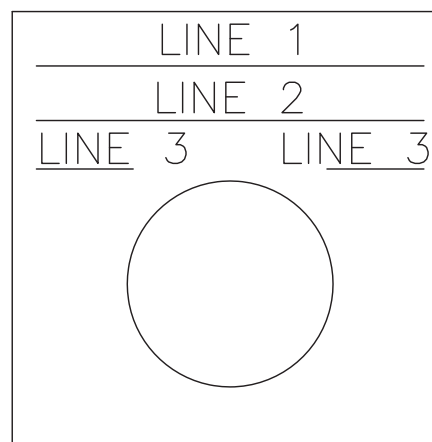

PANEL NAMEPLATE

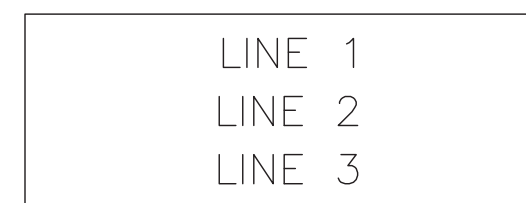

DEVICE TAG



NOTE:
 TEXT WILL REMAIN VERTICALLY CENTERED IF LESS THAN 3 LINES ARE USED.

<p>Property of EleMech, Inc. All rights reserved. No part of this drawing may be reproduced in any form without permission in writing from EleMech, Inc. EleMech, Inc. reserves the right to alter this data or the design of its equipment at any time, without prior notice and without incurring any obligation whatsoever.</p>	<input type="checkbox"/> Preliminary <input checked="" type="checkbox"/> For Approval	<input type="checkbox"/> Information Only <input type="checkbox"/> Dimensions Certified	This drawing is limited to functional design, general arrangement and clearance. No responsibility is accepted by EleMech, Inc for other dimensions, quantities, or coordination with other equipment or drawings except as stated in the purchase order.	By _____ Date _____	REV DESCRIPTION BY DATE	REFERENCE INFORMATION ELEMECH FILE: PAL9542A7	PROJECT NAME MILTON, IN I23070-70	DRAWN BY JJW	DATE 01/26/24	CHECKED BY BMG	DATE 01/26/24	SCALE NONE	TITLE BULK WATER FILL STATION CONTROL PANEL FS-20	DRAWING NO. PAL9542A7	REV 0
	SHEET 7 OF 7														

Bill of Materials



Rev: 0

Date: 01-30-2024

By: JJW

Section:

C

Job Number: PAL9542

Page # 1/1

Section Name: Bill of Materials

Item No.	Component	Description	Manufacturer Part Number	QTY	Device
Bulk Water Station Control Panel - FS20 (Quantity: 1)					
1	00-000-000	Wire, Hardware, Wire labels, etc.	EleMech: Miscellaneous	1	
2	10-069-001	Wireway Duct Cover, 1"W, 6 Ft. Section, w/Panduit F Series	Panduit: C1WH6	3	
3	10-069-007	Wireway Duct, 1"Wx3"H, 6 Foot Section	Panduit: F1X3WH6	3	
4	25-000-A002	Legendplate Assembly, White, Black Text, Standard Encl.	EleMech: 25-000-A002 Assembly	1	
5	25-000-A014	Nameplate Assembly, White: Power Supply - 1/60/120VAC	EleMech: 25-000-A014 Assembly	1	
6	42-063-007	Terminal Block, Din Rail, 35MM Wide, 15 High, 2 Meters Long	Iboco: Omega 3 AF	1	
7	51-000-062	Wire, MTW Type, 600V, 105°C, CSA/UL1015, Tinned Copper	EleMech: 51-000-062	1	
8	52-000-000	Label, Underwriters Laboratories 508A, w/Decal Set	EleMech: 508A	1	
9	52-641-000	Nameplate, Portalogic Fill Station w/QR, Stainless	Horizon: PP000561	1	
10	33-463-003	Antenna, High Gain w/G10 ePort, MCX, LTE, 8ft Cable	USA Technologies: VXWUP1101288	1	ANT1
11	03-058-122	Circuit Breaker, 1 Pole, 240VAC, 5A, 14kA, UL489, Type C	Square D: M9F42105	1	CB1
12	03-058-119	Circuit Breaker, 1 Pole, 240VAC, 2A, 14kA, UL489, Type C	Square D: M9F42102	2	CB2,3
13	57-000-009	Cable, Comm., Ethernet, Standard, RJ45M - RJ45M, 3'	Deep Surplus: CB242-3BL	1	CBL1
14	57-000-051	Cable, Barrel, 12VDC, 5.5mm x 2.5mm, Use w/EBOX	EleMech: CBL-5.5x2.5mm	1	CBL2
15	57-464-007	Cable, USB, A-Male - B-Male, 2.0, Black, Ferrites, 6'	Tripp Lite: U023-006	1	CBL3
16	89-000-003	Converter, Cable, USB 2.0 to DB-9 RS-232	EleMech: CB-DB9P	1	CONV1
17	42-063-004	Terminal Block, Ground, 30A, 600V, 6MM Wide, w/WK4/U	Wieland: 57.504.9055.0	5	DB,TB
18	07-063-000	Distribution Block, End Cover, 4 Pole, 300V,10A, w/WK4E\U\VB	Wieland: 07.311.4053.1	2	DB1
19	07-063-001	Distribution Block, Jumper, 4 Pole, 300V,10A, w/WK4E\U\VB	Wieland: Z7.210.3427	1	DB1
20	07-063-002	Distribution Block, Single Pole, 10A, 300V, WK4E\U\VB	Wieland: 57.404.6955.1	7	DB1
21	ELE-33-P009	Program, EBOX, Custom	EleMech: ELE-33-P009	1	EBOX
22	33-637-000	Industrial PC, ML100G-40, 2-LAN, 3-USB, Ryzen, notes	EleMech: ML100G-40-8GB-DIN-APO-64GBSSD	1	EBOX1
23	11-000-077	Inner Door Mounting Strip, Stainless, w/EleMech HS	EleMech: ELE-24MS	1	EN1
24	11-000-291	Inner Door, 304SS, No Cutouts, w/EleMech HS, CUSTOM	EleMech: ELE-24CR24-H-CUSTOM	1	EN1
25	11-023-051	Enclosure, Key Lock, Quarter Turn, w/EK333	Emka: 1048-U6	2	EN1
26	11-023-052	Cam, Quarter Turn, -8mm Offset	Emka: 1000-21	2	EN1
27	11-035-153	Sub-Panel, Painted Steel, w/24"Hx24"W Concept	Hoffman: C-P2424	1	EN1
28	11-035-815	Enclosure,Nema 4X,304SS,24"Hx24"Wx14"D,Concept,3-PT-MOD	Hoffman: C-SD242414SS-MOD-J4136	1	EN1
29	33-463-006	Pass Card, ePort	USA Technologies: BXXUG0100588	1	EPORT1

Item No.	Component	Description	Manufacturer Part Number	QTY	Device
30	33-463-008	Credit Card Package, USA Only, G11 ePort LTE, DB9, w/PS	Cantaloupe: VVLUT0202604	1	EPORT1
31	15-011-000	Ground Lug, 14AWG - 4AWG	Blackburn: L70	1	GND
32	124-599-007	HDMI Display Simulator Dongle	Adafruit: 4247	1	HDMI
33	17-000-003	Heater, Shield, SS, w/Stego: 06020 - Series	EleMech: 17-000-003	1	HTR1
34	17-628-000	Heater, 100-240VAC, 40 Watts, Convection Type	Omega DBK: 50H 40W	1	HTR1
35	52-137-003	Label, Caution: Heater Element, 1.5"Wx0.75"H, White/Red	Nameplate Tech: 52-137-003	1	HTR1
36	06-058-027	Control Relay Retension Clip, w/Telemec. RPM 1-Pole Relay	Square D: RPZR235	3	IR1-3
37	06-058-028	Control Relay, SPDT, 24VDC, 5Pin Spade, Operator, 15A	Square D: RPM12BD	3	IR1-3
38	38-058-009	Socket, 5 Pin Spade, Din Mount, Screw Term., w/ RPM 1-Pole	Square D: RPZF1	3	IR1-3
39	08-533-A004	Water Station Keypad, USB, SS, Start/Stop/Sel/Ent/Left/Down	EleMech: KP-SS-USB-S,S,S,E,L,D	1	KEYPAD1
40	52-000-066	Nameplate, Warning UPS Power Present	EleMech: J5331	1	LBL4
41	25-000-A010	Nameplate Assembly, White, Black Text, 1"Hx3"W	EleMech: 25-000-A010 Assembly	2	NP1,2
42	02-005-003	Contact Block, 1NO, w/A-B 800 Series	Allen-Bradley: 800T-XD1	1	PB1
43	29-005-121	Pushbutton, NEMA 4X, Operator Only, Mushroom, Red, Momentary	Allen-Bradley: 800H-DR6	1	PB1
44	33-475-009	Web Relay, 9-28VDC, 4-OPTO In, 4-Relay Out	Web Relay: X-410-I	1	PR1
45	26-000-000	Drip Shield, Clear Plastic, Double Sided Tape	EleMech: 26-000-000	2	PRN1
46	36-000-012	Printer, Mounting Bracket, Stainless Steel, w/TG2460	EleMech: 36-000-012	1	PRN1
47	36-338-002	Arm, Paper, w/Custom TG Series	Custom: 974CE010000001	1	PRN1
48	36-338-003	Printer, Serial/USB Interface, Auto Cutter, Custom TG2460	Custom: 915CG040200300	1	PRN1
49	36-443-000	Printer, Clear Receipt Cover, Adhesive Mount	EleMech: 36-443-000	1	PRN1
50	37-098-013	Power Supply, 60W, 85-264VAC IN, 24VDC OUT, NEC Class 2	Phoenix: 2902992	1	PS1
51	69-000-003	Resistor, 6.2k Ohms, 1/4Watt, 5% Tol	Yageo: CFR-25JB-52-6K2	1	R1
52	42-063-001	Terminal Block, End Plate, Gray, w/WK4/U	Wieland: 07.311.0155.0	1	TB
53	42-063-003	Terminal Block, Single Pole Gray, 30A, 600V, 6MM Wide, WK4/U	Wieland: 57.504.0055.0	20	TB
54	42-063-015	Terminal Block, Jumper, w/WK4/U, 02 pole, Insulated	Wieland: Z7.281.1227	1	TB
55	42-063-000	Terminal Block, Labels, Custom Printed, w/WK4/U	Wieland: 04.242.6353-CUSTOM	62	TB,DB
56	42-063-009	Terminal Block, End Clamp, w/WKN10/U	Wieland: Z5.522.8553	4	TB,DB
57	42-063-008	Terminal Block, Labels, Blank, w/WK4/U-(600 tags per box)	Wieland: Z4.242.6353	10	TB1
58	46-034-003	Thermostat, for heater control, N.C.contact, 6 amp,30-140 F.	Stego: 11100.9-00	1	TS1
59	48-591-001	UPS, DRC-100A, 120VAC In, 12VDC Out, 4.5A, DIN, Batt Rqd	Mean Well: DRC-100A	1	UPS1

Item No.	Component	Description	Manufacturer Part Number	QTY	Device
60	11-575-001	Ventilation Kit, Gray Poly, NEMA 4X, Set of 2	Allied: AMVENT4XLG	1	VENT1
Spare Parts / Ship Loose (Total Quantity Provided)					
61	101-564-001	Solenoid Control Valve, 3", ANSI 150, 24VDC SOV, Globe	Cla-Val: 3" 136-01YKC	1	SOV1
62	60-619-002	Flowmeter, 3", Omni C2 Water Meter, w/AMI, 5.7k Res Req	Sensus: 3 C2 1G 17LL 8WHL	1	FM1
65	61-000-012	Labor, Engineering, Submittal, Schematics, BOM	EleMech: 61-000-012	1	ENG
66	70-000-038	Software, Portalogic V.6, Digital License, Multi-User	EleMech: 70-000-038	1	PAL
67	48-592-001	UPS, Battery, 12VDC, 15Ah, F2 Spade Term	SigmasTek: SP12-15 F2 - package of 2	1	BATT1
68	36-338-001	Printer, Paper, Thermal, 1 Ply, w/Custom TG Series	Custom: 603518 (RCT60X55) - P6035/8	5	PAPER

PortALogic User Manual



Rev:	0
Date:	01-30-2024
By:	JJW

Section:	D	
Job Number:	PAL9542	Page #
		1/1

Section Name:	PortALogic User Manual
---------------	------------------------



Portalogic 6 User Manual

Version 1.34

EleMech, Inc.
2275 White Oak Circle
Aurora, IL 60502

p. (630) 499-7080
f. (630) 499-7760

www.portalogic.info
www.elemechinc.com

Table of Contents

I.	Chapter 1: About Portalogic.....	4
	About the Portalogic System	4
	Portalogic Management Software	4
	Minimum System Requirements	5
II.	Chapter 2: Portalogic SQL Setup	6
	Installing SQL Server	6
	Installing SQL Server Management Studio	9
III.	Chapter 3: Portalogic Installation.....	11
	Database Setup	11
	Setting the Cloud Job Number	12
	Create Database Login	14
	Portalogic Data Service	16
	Internet Information Services (IIS) Setup	17
	Exchange Mail Server Configuration.....	24
IV.	Chapter 4: Portalogic Web App.....	26
	About Portalogic	26
	Starting Portalogic.....	26
	Database Design	27
	Navigating Portalogic.....	27
	Using the Grid	29
	Sidebar Menu Screens	32
	Menu Navigation	34
	Facility Menu.....	37
V.	Chapter 5: Reports	40

	Generating Reports.....	40
	Activity Reports.....	40
	Customer Statements	41
	Revenue Reports.....	42
	Customer Truck List	43
VI.	Chapter 6: Troubleshooting	44
	Portalogic	44
	ePort.....	45
	Printer	48
VII.	Chapter 7: Auto Backup	49
	Prepare PowerShell.....	49
	Create a Stored Procedure.....	50
	Schedule Auto Backup	52
	Manual Backup	53
VIII.	Chapter 8: Diagrams	55
IX.	Chapter 9: Technical Support.....	57

Copyright © 1987-2021, (Documentation and Software) EleMech, Inc. 2275 White Oak Circle
Aurora, Illinois, USA 60502. All rights reserved.

No part of this documentation may be stored in a retrieval system, transmitted or reproduced in any way, except in accordance with the terms of the applicable software license agreement. This documentation contains proprietary information of Portalogic software that is solely owned by EleMech, Inc.

Trademark Acknowledgments

Portalogic is a trademark of EleMech, Inc.

Windows® and Windows SQL Server® are registered trademarks of Microsoft Corporation.

All other product and company names mentioned herein may be the trademarks or registered trademarks of their respective owners.

Chapter 1: About Portalogic

About the Portalogic System

Portalogic management software provides facilities with the means for managing transported water and waste. Portalogic is a web-based application that can be accessed by any number of users on a network. This software is included with the purchase of any Portalogic water or waste station.

All Portalogic stations are designed for haulers to use with little to no operator supervision. The stations provide identification, access to the equipment that is necessary for the pickup or delivery, and monitoring. The management software provides automated record keeping, reporting, and billing for the water/waste being transported, and real-time communication with water and/or waste stations. This system gives facilities complete control over their unattended stations.

Portalogic Management Software

The Portalogic Management Software automates the pickup/delivery of water/waste and manages the associated customers, trucks, billing, monitoring, revenue, and more. The software application consists of three parts:

1. Portalogic IIS Web service
2. Microsoft SQL Database
3. Portalogic Web Application

Portalogic provides control of the water/waste stations by synchronizing the data exchanges between the Microsoft® SQL Server database and office staff. The Portalogic Web Application provides a user interface for office staff to control the water/waste stations, manage customer and truck accounts, and generate reports.

Minimum System Requirements

Before installing Portalogic, it is important to ensure that the capacity of your computer system is sufficient both to install and to run the application. EleMech suggests the following minimum system requirements:

- Operating System: 64-bit Windows 10 or later / Windows Server 2016 or later
- CPU: 4 cores
- RAM: 8 GB
- Hard Drive: 20 GB free space
- Network: 1 Gbps / 100 Mbps Ethernet Connection

Chapter 2: Portalogic SQL Setup

Installing SQL Server

if an SQL database is already in place and is to be utilized, skip to Chapter 3. Full local administrative access will be required for the installation and internet access.

1. Download SQL Server Express from Microsoft’s website: <https://www.microsoft.com/en-us/sql-server/sql-server-downloads> → run executable
2. Installation type: Custom → Choose a media location and click “Install” (you can delete this folder once done)



Figure 1: New SQL Server Installation

3. After reading the Software License Terms, check “I accept the license terms”, click “Next”.
4. Leave the Instance Features selections as default and click, “Next”.
5. Select the Named Instance option. Specify a named instance for SQL Server. Be sure to write down the named instance chosen, as you will need it later. The default is SQLExpress. After specifying a named instance, click “Next”:

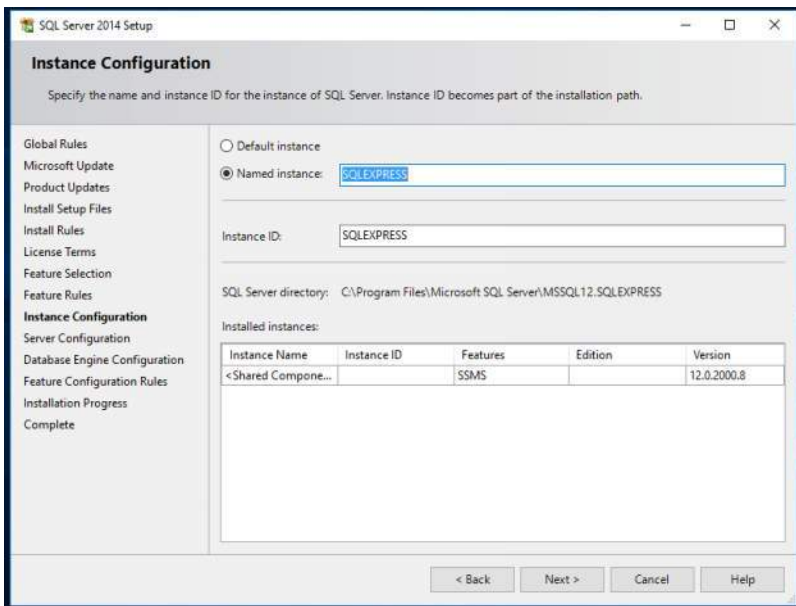

Figure 2: SQL Server Instance Configuration

6. Leave the Server Configuration selections as default unless told otherwise by a local database administrator and click “Next”.
7. In the Database Engine Configuration page, select the option “Mixed Mode”. Create and **document** a password for the SQL Server System user “sa”. This password must be at least 8 characters long and contain 3 of the 4 criteria:
 - a) Contain uppercase letter(s)
 - b) Contain lowercase letter(s)
 - c) Contain non-alphanumeric characters, such as “#” or “%”
 - d) Contain number(s)
8. Once the password has been entered into the Enter Password and Confirm Password lines, click Next

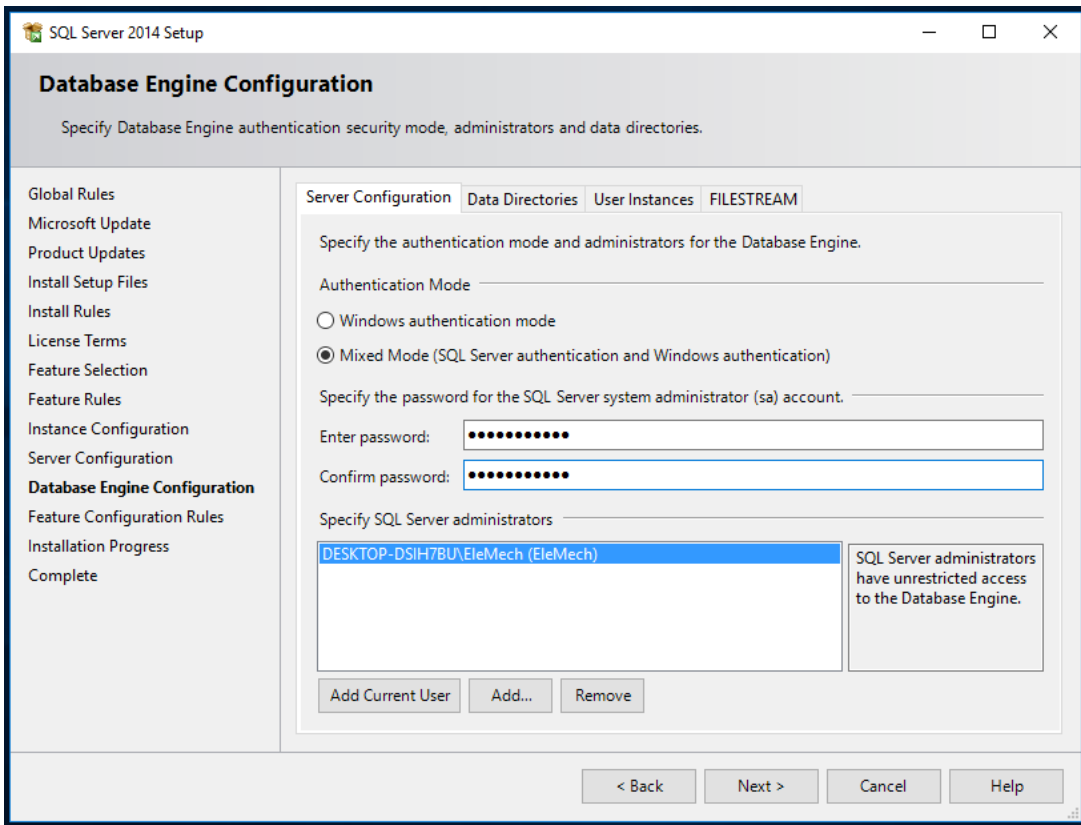

Figure 3: SQL Server Mixed Mode

9. Click “Next”. SQL Server will then begin to install.
10. When SQL Server installation is complete, click “Close” to exit the window.

Installing SQL Server Management Studio

1. Download the installation file from Microsoft's website: <https://docs.microsoft.com/en-us/sql/ssms/download-sql-server-management-studio-ssms>
2. If prompted with a security pop-up, allow the program to make changes to your computer.
3. Click on "New installation or add features to an existing installation".
4. Select "Add features to an existing instance of SQL Server" and select the name of the previously created server. Click "Next".

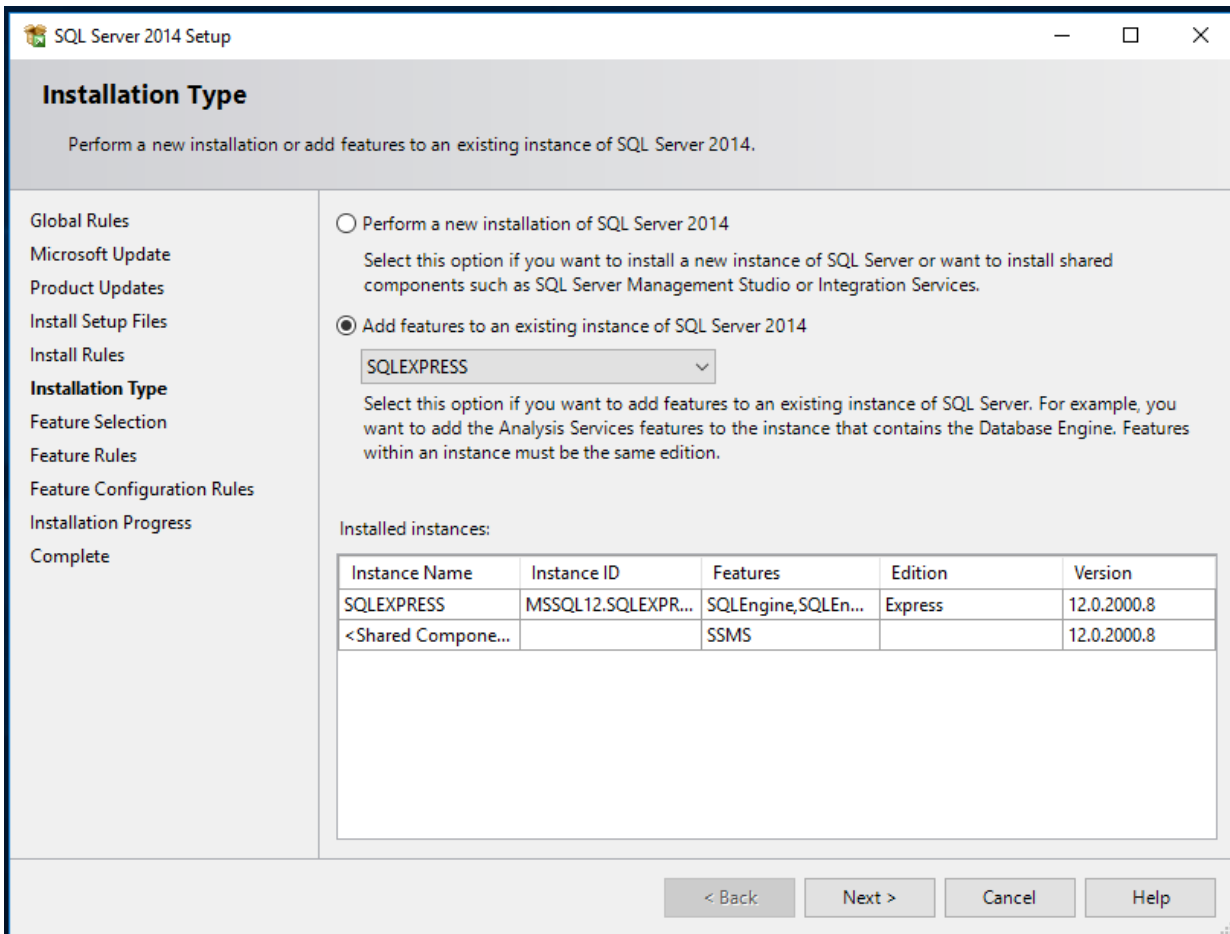

Figure 4: SQL Management Studio Installation

5. Select “Management Tools - Basic” only and select “Next”.

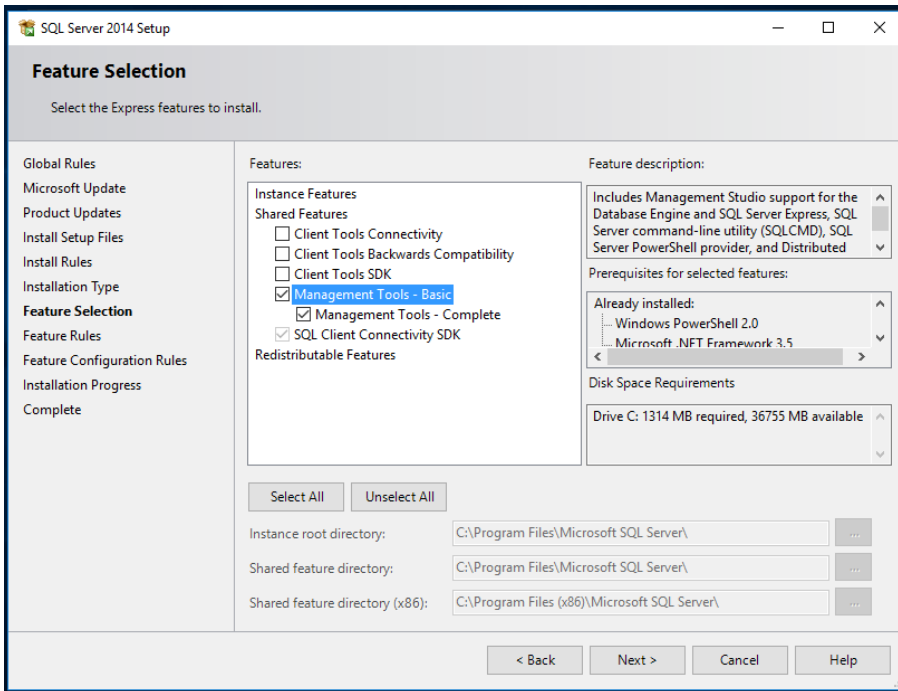



Figure 5: SQL Management Studio Feature Selection

6. SQL Server Management Studio installation is now complete. Click “Close” to exit the window.

Chapter 3: Portalogic Installation

Database Setup

1. Click  Start
2. Search for SQL Server Management Studio or “SSMS”.
3. Login with the Server Type: “Database Engine”
4. Server Name: “(Local)\SQLEXPRESS”
5. Click “Connect”.
 - a) **NOTE:** If an existing SQL instance is being used or a remote one, “SQLEXPRESS” may not apply.
6. Right click on the “Databases” Folder and select “New Database”.
7. Name the new database “Portalogic5” and click “OK”.
 - a) **NOTE:** Make sure it is called “Portalogic5” not “Portalogic6”.
8. Click the “New Query” Button. Press the “Open File” button  and open the file “Portalogic.sql” in the installation files, then press “Execute” to run the script.

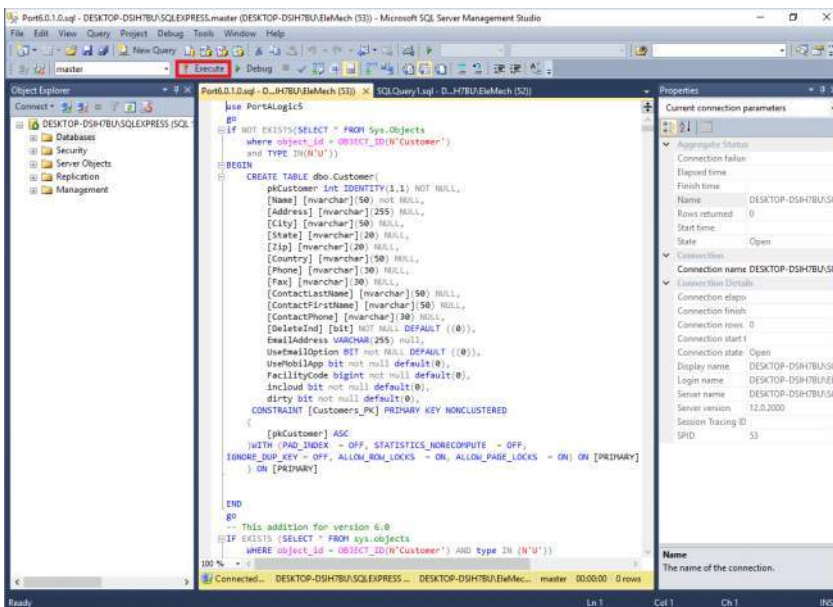



Figure 6: SQL Management Studio execute database script

Setting the Cloud Job Number

To add customers to Portalogic a Cloud Job Number is needed, otherwise you will get the following error message:

① Cloud Job Number is blank. Please contact Elemech.

To avoid this this error, you must enter your Cloud Job Number into the following SQL Server Management Studio directory path:

1. Click  Start
2. Search for “SQL Server Management Studio”
3. Drill Down to “dbo.LocalPLC” by completing the following steps:

- a) Expand “(Local)\SQLEXPRESS”
- b) Expand “Databases”
- c) Expand “Portalogic 5”
- d) Expand “Tables”
- e) Navigate to and right click “dbo.LocalPLC”
- f) Select “Edit Top 200 Rows” from the drop-down menu
- g) Locate the tab “TelerikCloudJobNumber” or “JobNumber”
 - i. NOTE: The text in this tab may be cut off, so it may appear as “TelerikCloudJo...”
- h) In the box directly beneath that tab, type in the Job Number Provided to you.
 - ii. NOTE: You can find this number in bottom right corner of the electrical drawings shipped with your panel. It should be in a three letter/four number format, i.e ABC1234

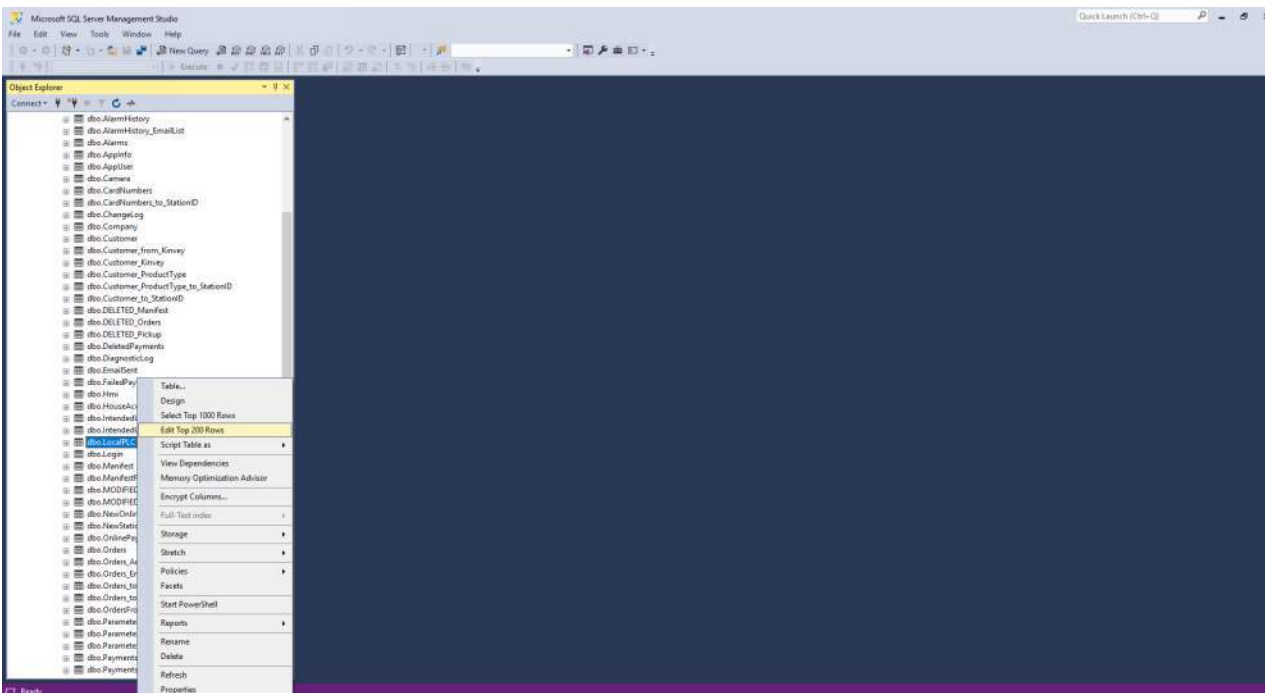

Figure 7: Setting Up Cloud Job Number

	pkPLC	Name	StationID	CloudMySQLIP	Cloudtype	CloudSchema	TelerikCloudJo...
	1	Office	0	173.194.233.26	1		Tes1234
▶*	NULL	NULL	NULL	NULL	NULL	NULL	NULL

Figure 8: TelerikCloudJobNumber Tab

Create Database Login

1. (local)SQLEXPRESS

- a) Security
- b) right click “Logins” folder
- c) New Login
- d) Login name: “portuser”
 - i. SQL Server authentication → Password and Confirm password: “1234”
 - ii. Uncheck “Enforce password policy” → Click “OK”

Login - New

Select a page

- General
- Server Roles
- User Mapping
- Securables
- Status

Script Help

Login name: portuser Search...

Windows authentication

SQL Server authentication

Password:

Confirm password:

Specify old password

Old password:

Enforce password policy

Enforce password expiration

User must change password at next login

Mapped to certificate

Mapped to asymmetric key

Map to Credential Add

Mapped Credentials

Credential	Provider
------------	----------

Remove

Default database: master

Default language: <default>

OK Cancel

Figure 9: SQL Management Studio new user

2. Databases → Portalogic5 → Security → right click on “Users” folder → New User...
 - a) User name: portuser
 - b) Login Name: portuser
 - c) Default Schema: Leave blank
 - d) Select a page → Owned Schemas → check “db_owner”
 - e) Select a page → Membership → check “db_owner”

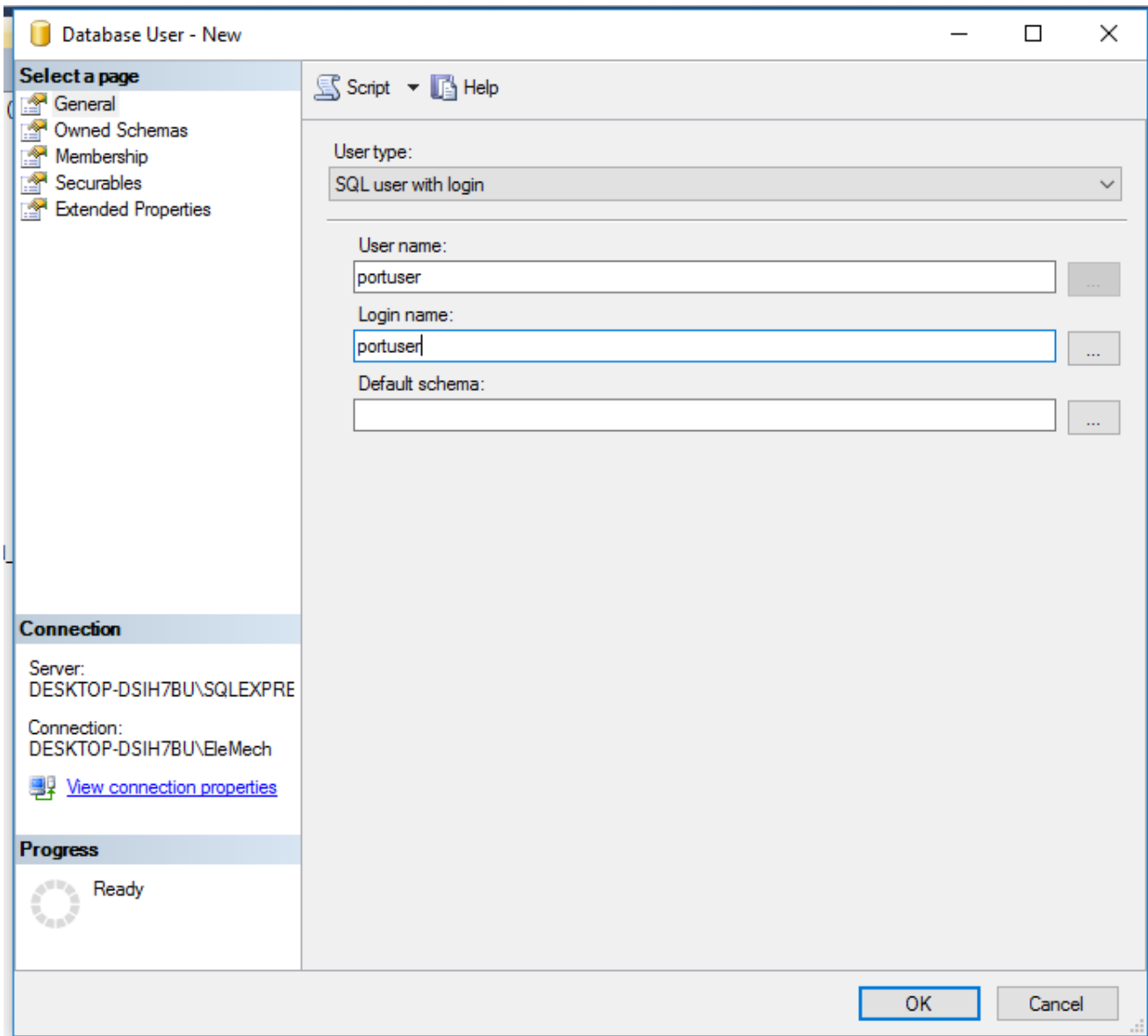



Figure 10: SQL Management Studio database user

Portalogic Data Service

1. Download and install Node.js LTS version (use all default options): <https://nodejs.org/en/download/>
2. Download and install Git for Windows (use all default options): <https://git-scm.com/download/win>
3. Search Windows for "SQL Server Configuration Manager"
 - a) Expand "SQL Server Network Configuration" and expand "Protocols for SQLEXPRESS"
 - b) If you cannot find it: Windows Key + R → compmgmt.msc → Services and Applications → SQL Server Configuration Manager → SQL Server Network Configuration
 - c) Double click on "TCP/IP" and set "Enabled" to "Yes"
 - d) Click the "IP Addresses" tab and underneath the "IPAll" tab set "TCP Port" to "1433"
 - e) Click "OK" on the Warning that the service will have to be restarted
 - f) Click on "SQL Server Services"
 - g) Right click on "SQL Server (SQLEXPRESS)" and choose "Restart"
4. Create a folder named "EleMech" within this directory: "C:\Program Files (x86)".
5. Copy and paste the files within "Copy Files to EleMech Folder" to inside the folder you just created: "C:\Program Files (x86)\EleMech" .
6. Within the "PortalogicDataService" folder, right click on "install-admin.bat".
 - a) The computer will need internet access during this process. If that is not possible, EleMech will need to be contacted for a more advanced installation.
7. Select "Run as Administrator" from the drop-down menu.
 - a) **NOTE:** Check for any errors that may arise. If a non-default installation directory is required, edit this file and change the INSTALL_DIR at the top.
8. If default directories or database login information need to change, please change the settings in these files:
 - a) POData\Web.config
 - b) PortalogicDataService\config.json
 - i. After changes, restart the service. Follow the steps outlined on page 25.
 - c) Portalogic6\Reports
 - i. Change "ConnectionString" at top of all files

Internet Information Services (IIS) Setup

1. Install IIS and ASP.NET 4.8

- a) Click  Start → Turn Windows Features on or off
- b) Check “.NET Framework 4.8 Advanced Services”, “Internet Information Services”, and “ASP.NET 4.8” within Internet Information Services → World Wide Web Services → Application Development Features. Leave all boxes checked that were done so automatically when you clicked on them.
- c) OK → Wait for installation to complete

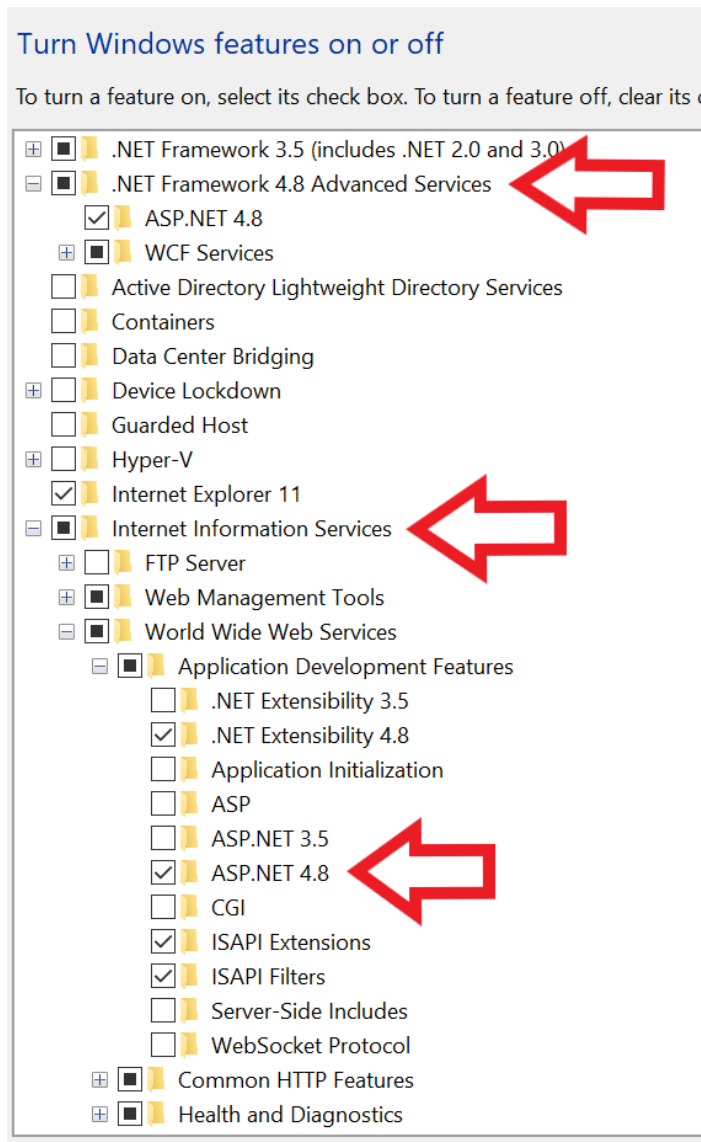



Figure 11: ASP.NET and IIS Installation

2. Click  Start
3. Search for IIS (Internet Information Services)
4. On the left-hand pane, drill down to Sites
5. Right click on “Default Web Site”
6. Select “Add Application”

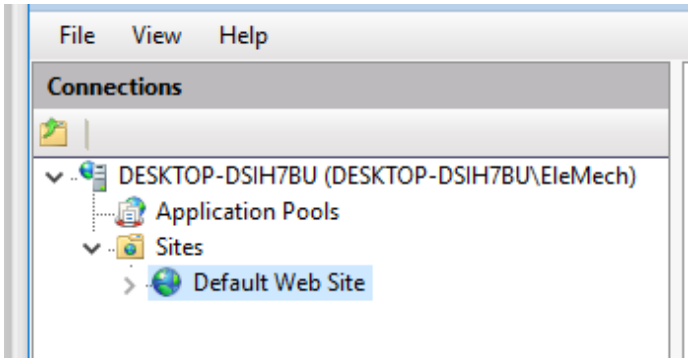

Figure 12: Internet Information Services – drilldown

7. Type in “PortOData4” in the Alias textbox. Press the “...” button next to the “Physical Path” textbox. Navigate to the “OData” folder, select it, and click “Ok”. The “OData” folder is located under “C:\Program Files (x86)\Elemech\POData”. Click the “Ok” button to add the application.

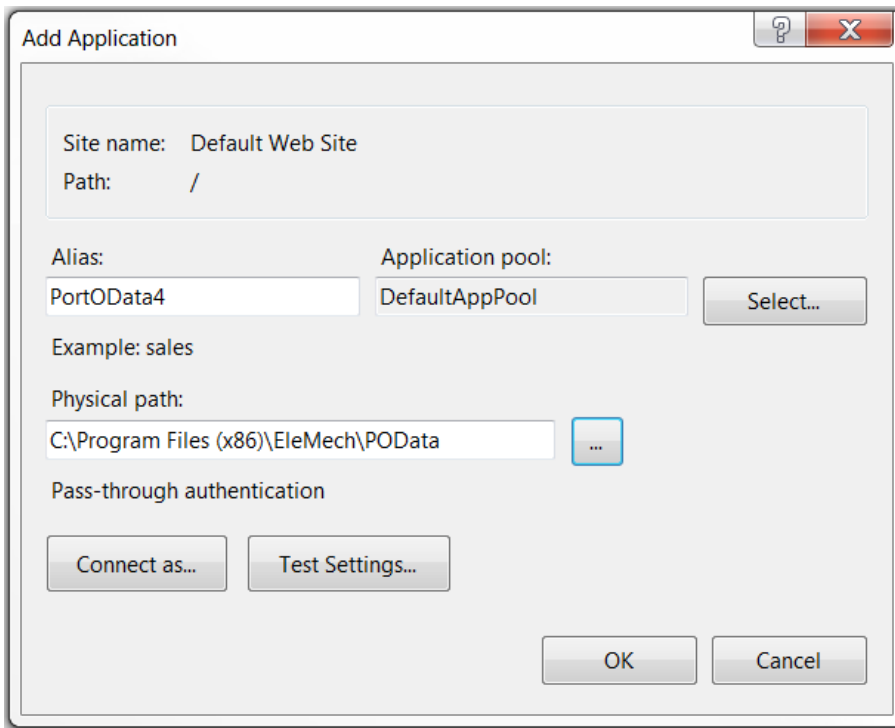

Figure 13: Internet Information Services - OData Website

8. Select "PortOData4" in the "Connections" pane → select "Browse *.80 (http)" under the right-hand side "Actions" pane.

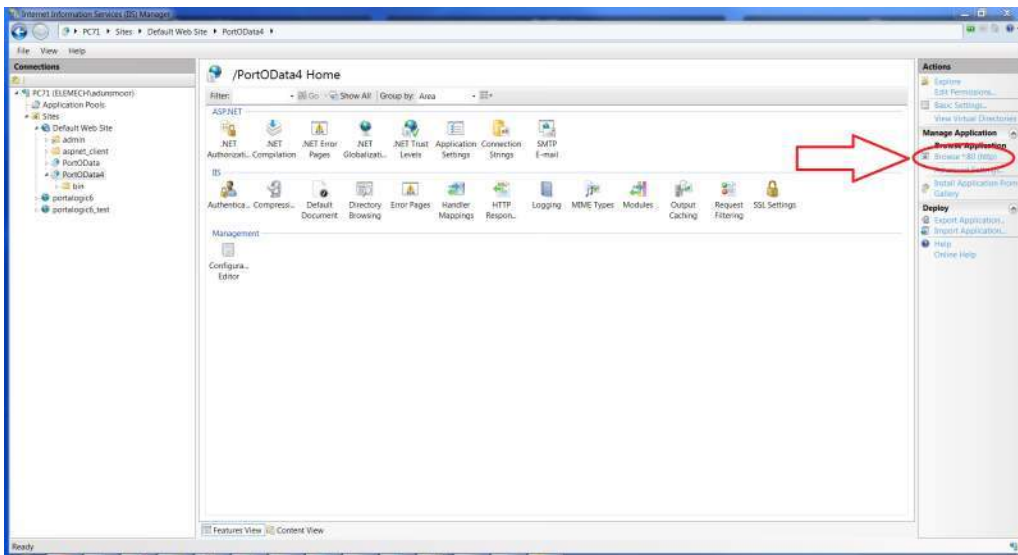

Figure 14: Internet Information Services - Browse WCF

9. It should show without errors after a few seconds.

```
{
  "@odata.context": "http://localhost/PortOData4/$metadata", "value": [
    {
      "name": "Users", "kind": "EntitySet", "url": "Users"
    }, {
      "name": "IntendedUses", "kind": "EntitySet", "url": "IntendedUses"
    }, {
      "name": "Deletables", "kind": "EntitySet", "url": "Deletables"
    }, {
      "name": "Customers", "kind": "EntitySet", "url": "Customers"
    }, {
      "name": "Trucks", "kind": "EntitySet", "url": "Trucks"
    }, {
      "name": "WasteGenerators", "kind": "EntitySet", "url": "WasteGenerators"
    }, {
      "name": "Companies", "kind": "EntitySet", "url": "Companies"
    }, {
      "name": "Stations", "kind": "EntitySet", "url": "Stations"
    }, {
      "name": "ProductTypes", "kind": "EntitySet", "url": "ProductTypes"
    }, {
      "name": "GenericFunctions", "kind": "EntitySet", "url": "GenericFunctions"
    }, {
      "name": "Orders", "kind": "EntitySet", "url": "Orders"
    }, {
      "name": "Payments", "kind": "EntitySet", "url": "Payments"
    }
  ]
}
```

Figure 15: OData successfully hosted

10. If the page shows errors, ensure that your .NET version is 4.8 or higher. Download it from Microsoft and install it if needed.

11. (Optional) Test table loading data by copying and pasting this URL into a browser:

<http://localhost/PortOData4/Users?apikey=SG.fKTNqAgER4CI31NnK92XzA.gr2G8G7lpfw1M394XnIBZ0h>

```
// 20200309105337
// http://localhost/PortOData4/Users?apikey=SG.fKTNqAgER4CI31NnK92XzA.gr2G8G7lpfw1M394XnIBZ0h

{
  "@odata.context": "http://localhost/PortOData4/$metadata#Users",
  "value": [
    {
      "UserID": 1,
      "FunctionResult": null,
      "ReturnCode": 0,
      "RoleID": 1,
      "Role": "Administrator",
      "UserName": "admin",
      "Name": "admin",
      "Password": "admin"
    }
  ]
}
```

Figure 16: OData Users Table Test

12. Right click on “Sites” → select “Add Website...”

- a) Site name: “portalogic6”
- b) Physical path: “C:\Program Files (x86)\EleMech\Portalogic6”
- c) Binding: Port 84 (if port 84 is unavailable, use another number)

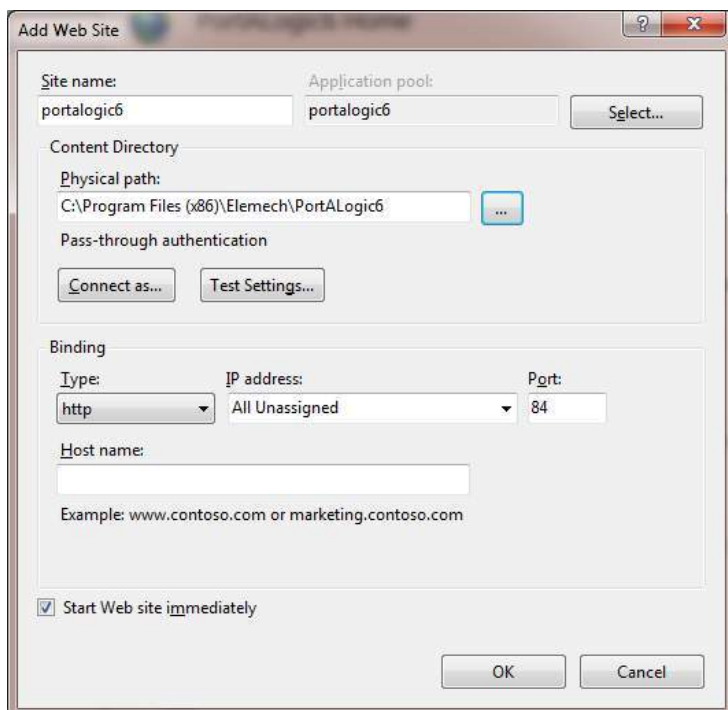

Figure 17: Internet Information Services - add Portalogic6

- d) Ensure that the Application Pool is using ASP.NET 4.0 or higher.
- e) Select “Application Pools” in the top of the left pane
 - i. **NOTE:** “portallogic6” should show “.NET CLR Version” as v4.0 or higher, if it is not, change it
- f) Select “portallogic6”:
 - i. Basic Settings
 - ii. Select the “.NET CLR version” dropdown and select v4.0 or higher
 - iii. Click “OK”

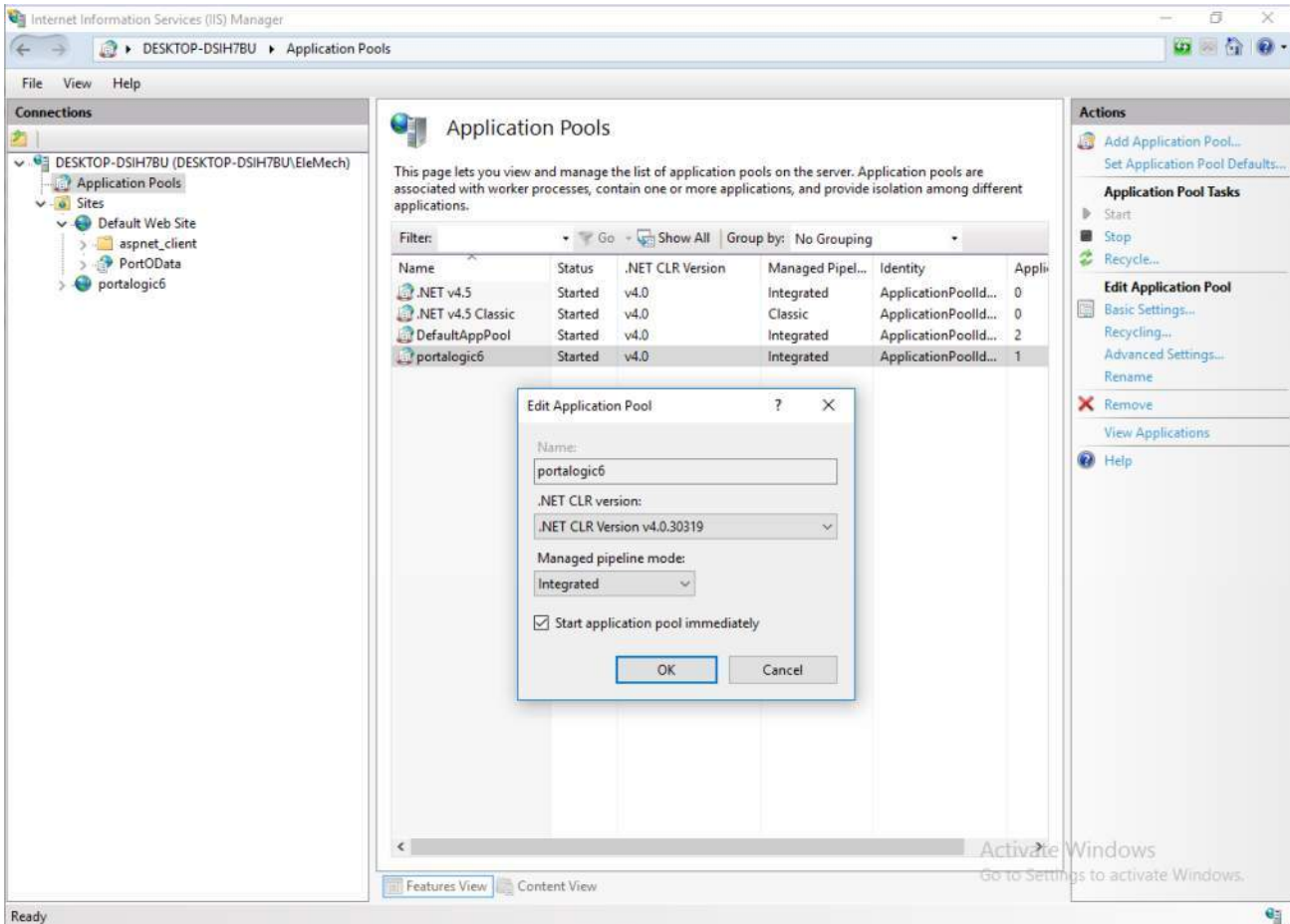

Figure 18: Internet Information Services - Application Pool

g) Ensure that ASP .NET is working properly

- i. In a Browser, navigate to <http://127.0.0.1:84> (use the correct port number if it was changed in step 12. The results should look like Figure 19.

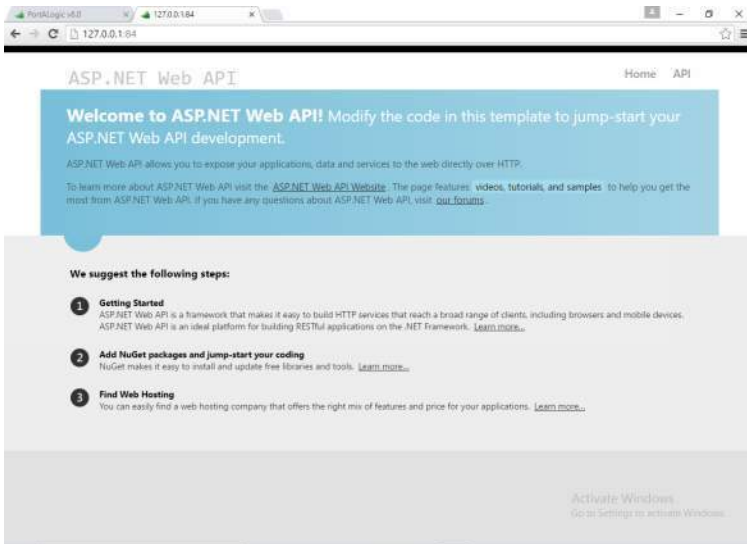



Figure 19: ASP.NET Web API Successful

13. The Firewall needs to be set to allow the Portalogic website to be accessed on other computers.

- a) Click 
- b) Search Windows Firewall
- c) Advanced Settings (left panel)
- d) Inbound Rules

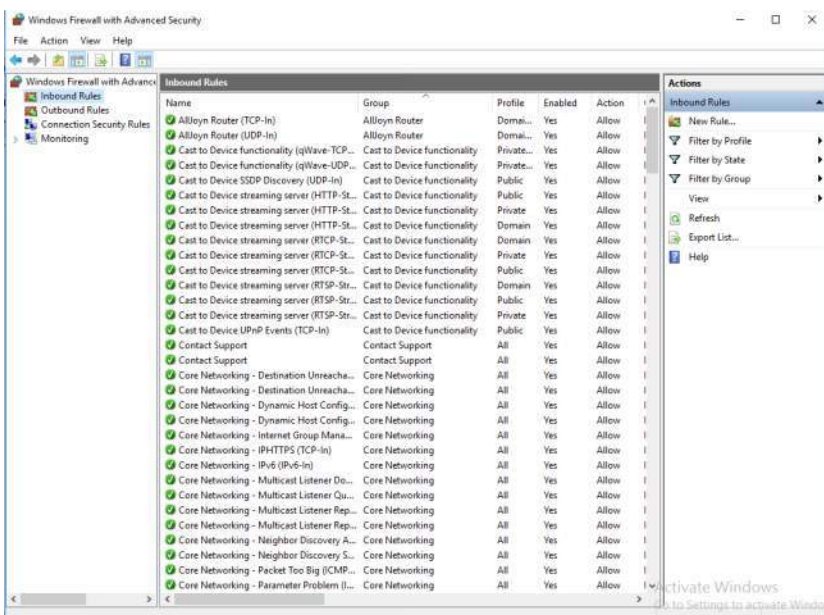
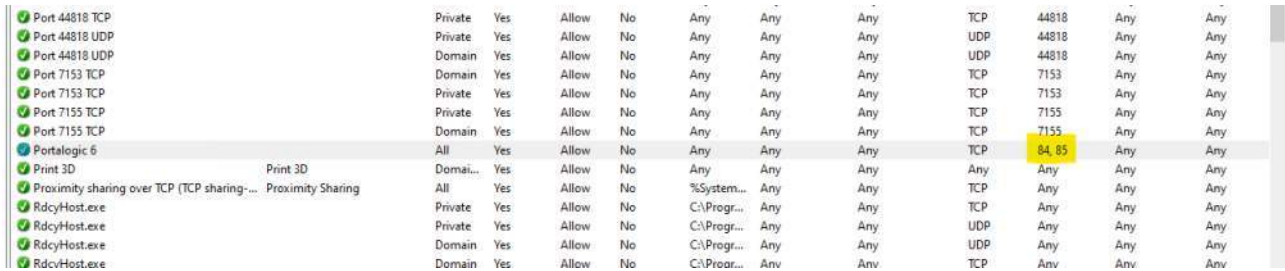

Figure 20: Windows Firewall - Inbound Rules

e) New Rule (top right-hand panel)

- i. Port TCP, Specific local ports: 84 (or the website port used previously)
- ii. Allow the connection
- iii. Domain, Private, Public (checked)
- iv. Name: Portalogic 6 Website Port (or another of your choosing)



Port 44818 TCP	Private	Yes	Allow	No	Any	Any	Any	TCP	44818	Any	Any
Port 44818 UDP	Private	Yes	Allow	No	Any	Any	Any	UDP	44818	Any	Any
Port 44818 UDP	Domain	Yes	Allow	No	Any	Any	Any	UDP	44818	Any	Any
Port 7153 TCP	Domain	Yes	Allow	No	Any	Any	Any	TCP	7153	Any	Any
Port 7153 TCP	Private	Yes	Allow	No	Any	Any	Any	TCP	7153	Any	Any
Port 7155 TCP	Private	Yes	Allow	No	Any	Any	Any	TCP	7155	Any	Any
Port 7155 TCP	Domain	Yes	Allow	No	Any	Any	Any	TCP	7155	Any	Any
Portalogic 6	All	Yes	Allow	No	Any	Any	Any	TCP	84, 85	Any	Any
Print 3D	Domain	Yes	Allow	No	Any	Any	Any	Any	Any	Any	Any
Proximity sharing over TCP (TCP sharing-...)	All	Yes	Allow	No	%System...	Any	Any	TCP	Any	Any	Any
Proximity Sharing	Private	Yes	Allow	No	C:\Progr...	Any	Any	TCP	Any	Any	Any
RdcyHost.exe	Private	Yes	Allow	No	C:\Progr...	Any	Any	UDP	Any	Any	Any
RdcyHost.exe	Domain	Yes	Allow	No	C:\Progr...	Any	Any	UDP	Any	Any	Any
RdcyHost.exe	Domain	Yes	Allow	No	C:\Progr...	Any	Any	TCP	Any	Any	Any

Figure 21: Windows Firewall - Port 84, 85 Opened

14. Allow log file viewing over browser (optional)

a) In IIS, uncollapse “Default Web Site”

- i. Left click “logs” (created in Portalogic Data Service)
- ii. Directory Browsing
- iii. Open Feature
- iv. Enable

b) Back to “logs” Home

- i. MIME Types
- ii. Open Feature
- iii. Add...

- File name extension: .log
- MIME type: text/plain

c) You can now browse this directory for Portalogic log files: <http://localhost/logs>

Exchange Mail Server Configuration

If your facility has an Exchange Server you would like to use for sending Portalogic email, please follow these steps.

1. Run “TestMail.exe” located at “C:\Program Files (x86)\Elemech\Utilities”.
2. Fill out the Mail Test form and click “Test Send”. If the recipient you entered receives an email, the parameters entered are correct. You may leave “User Name (to logon to exchange)” blank if no authentication is required.

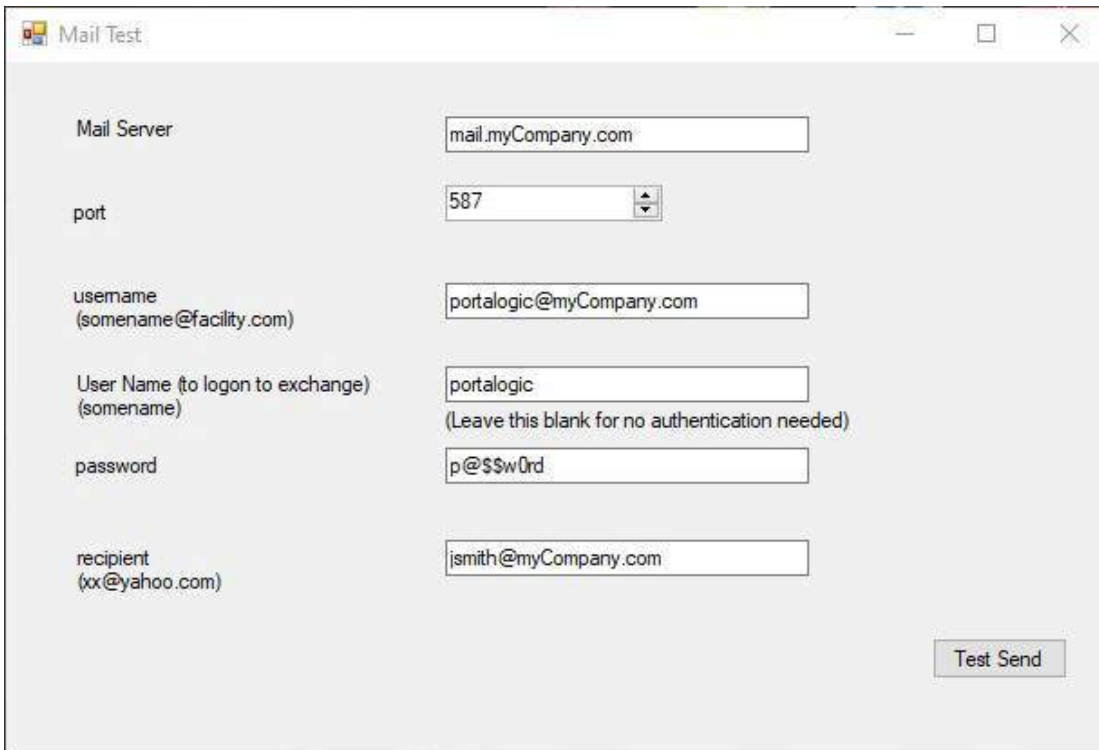

The screenshot shows a window titled "Mail Test" with the following fields and values:

Mail Server	mail.myCompany.com
port	587
username (somename@facility.com)	portalogic@myCompany.com
User Name (to logon to exchange) (somename)	portalogic (Leave this blank for no authentication needed)
password	p@\$w0rd
recipient (xx@yahoo.com)	jsmith@myCompany.com

A "Test Send" button is located at the bottom right of the form.

Figure 22: Outlook Test Email Configuration

3. Configure Portalogic to use the parameters you have just tested:
 - a) Navigate to "C:\Program Files (x86)\EleMech\PortalogicDataService"
 - b) Open the file "config.json" and enter the parameters from your successful Mail Test as the values in "email.smtpConfig.prod". Ensure that "useSMTP" is true.
4. Restart the Portalogic Data Service
 - a) Search Windows for "Node.js Command Prompt" and run it as administrator.
 - b) Run this command: "pm2 ls".
 - c) Find the id of "portalogic-data-service" and replace the "#" in the following command with the id number: "pm2 restart#".
5. Send a test email from Portalogic.
 - a) Open Portalogic 6 (or refresh the page if it is already open) and log in.
 - b) In the sidebar, click Facility → Email Setup.
 - c) Set Email Used to "Yes" and click "Save".
 - d) Enter a Test Email Address and click "Test" → Verify receipt of email.
 - e) If your test email was received, your configuration is working. You may now enter email addresses into the Alarm Recipients field. Separate emails with a comma, and click "Save" to complete the process.

Chapter 4: Portalogic Web App

About Portalogic

The Portalogic web app allows users to access information that Portalogic stations acquire. Portalogic may be accessed on any number of PCs on the same network as the Portalogic Service detailed previously and offers different access privileges for its software users. Portalogic can be viewed using Chrome (preferred) or Firefox browsers, the application will not work when using Microsoft Internet Explorer or the updated internet browser, Microsoft Edge.

Starting Portalogic

To Start Portalogic on the machine hosting the IIS server, open your **Google Chrome** browser and type in the network address: “<http://127.0.0.1:84/index.html>” (port 84 may be different if you used a different port in Figure 17). On a remote networked PC, type: “[http://\(the IP address of the IIS machine\):84](http://(the IP address of the IIS machine):84)”. i.e. “<http://192.168.2.45:84/index.html>”. EleMech recommends creating a browser shortcut on your desktop so that Portalogic can be accessed faster without typing in a network address each time. If you do not know the network address, please contact EleMech technical support.

Logging In

To improve security, Portalogic requires a valid login in order to access the program. When the application Starts, the login page appears. Enter a username and password and click “Login”. Default username/password: admin/admin.



Figure 23: Portalogic Login

Database Design

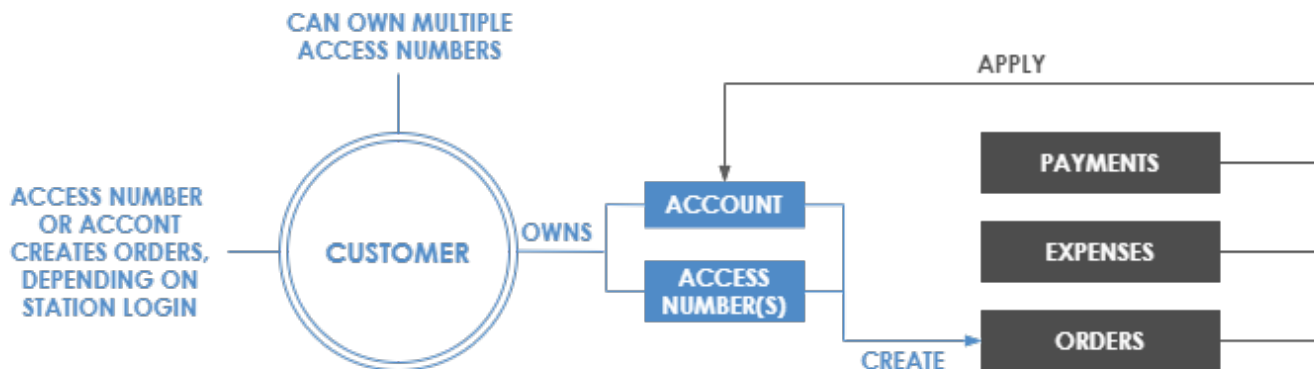

Figure 24 - Portalogic Database Design

The database is composed of five primary parts (see Figure 33). A customer owns an account with as many access numbers as required. Accounts and access numbers may create orders. Orders and payments/expenses apply to the customer's account. To login at a station, a customer must enter an access number and PIN. Access numbers may be assigned to fobs, swipe cards, proximity cards, or NFC cards, allowing customers to login using these methods (all methods require PIN entry). They can also be assigned to a truck for further identification.

Navigating Portalogic

Portalogic features four areas for navigation: the primary navbar, the secondary navbar, the sidebar menu, and the quick access menu. See figure 40 for reference.

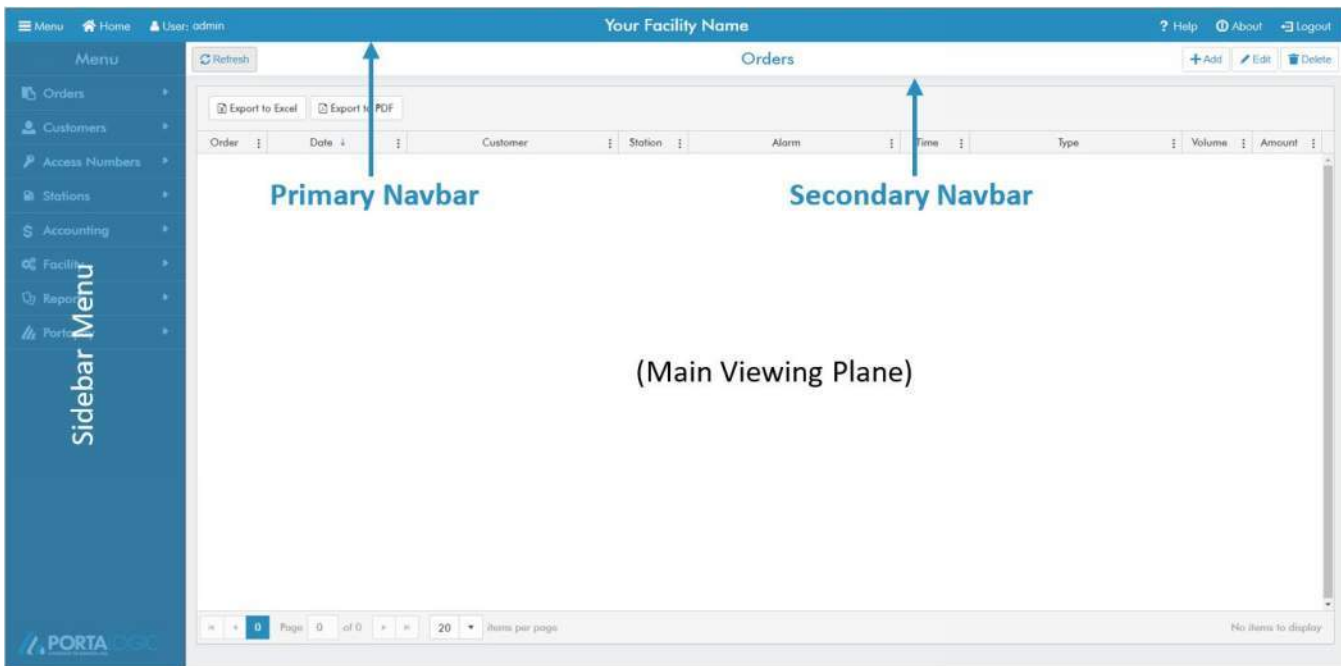

Figure 25: Navigation Areas

Primary Navbar

The primary navbar stretches the full width of the screen across the top in blue. It is always accessible and contains the following:

- **Menu:** clicking this button toggles the sidebar menu open or closed
- **Home:** an always accessible link to the home screen
- **User:** your username is displayed here
- **Facility:** the name of your facility appears in the center of the navbar
- **Help:** EleMech’s contact information and Portalogic activation input field
- **About:** a window containing Portalogic’s version number and copyright information
- **Logout:** click here when you wish to logout

Secondary Navbar

The secondary navbar is found across the top of the main viewing pane in white. It contains buttons specific to each screen (Orders, Customers, Access Numbers, etc...), and changes with each screen. Buttons appearing on the secondary navbar are described in the “Using the Grid” section and the individual screen sections. The title of the screen always appears in the center of the secondary navbar.

Sidebar Menu

The sidebar menu contains links to each screen, it is located on the far left and is always accessible. Clicking a link to a screen will cause that screen to slide into view in the main viewing pane. Clicking the Portalogic logo at the bottom of the menu will open portalogic.info in another tab in your browser. The sidebar may be collapsed by clicking the “Menu” button on the primary navbar described above, which expands the main viewing pane. When collapsed, only icons for each screen are visible.

Some links lead to sub navigation views (Facility and Reports, for example), which will slide into view within the sidebar. A back button will appear at the top of the sidebar which allows you to navigate back to its default view. Pressing the “home” button on the primary navbar will also return the sidebar to its default view.

Using the Grid

Portalogic displays the data it collects in a series of grids, viewable via the links in the sidebar menu. Clicking on a cell in a grid will select its row and highlight both the cell and its row. Each row represents an individual item on each grid (a row is an order on the Orders grid, a customer on the Customers grid, a truck on the Trucks grid, etc...), with columns providing data relevant to that item.

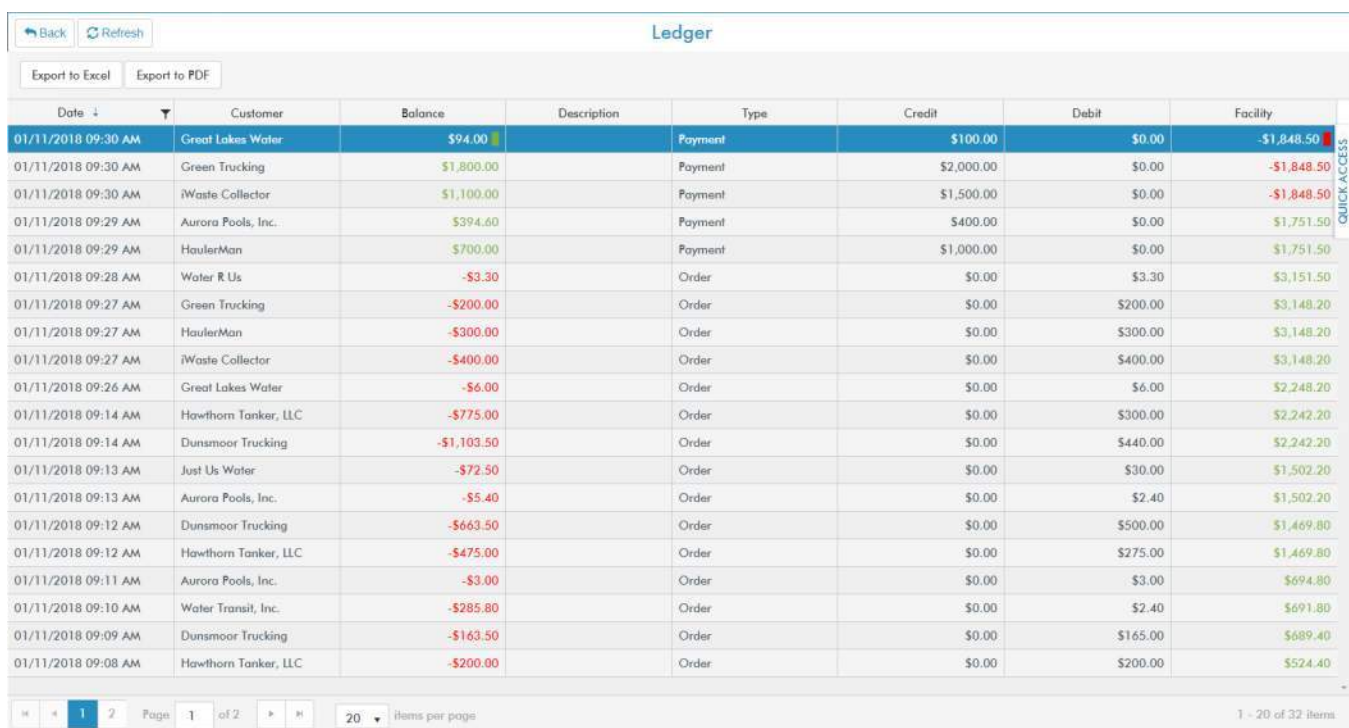

The screenshot shows a 'Ledger' grid with the following columns: Date, Customer, Balance, Description, Type, Credit, Debit, and Facility. The grid contains 20 rows of transaction data. The first row is highlighted in blue. At the top of the grid, there are buttons for 'Back', 'Refresh', 'Export to Excel', and 'Export to PDF'. On the right side, there is a vertical 'QUICK ACCESS' button. At the bottom, there is a pagination control showing 'Page 1 of 2' and '20 items per page'.

Date	Customer	Balance	Description	Type	Credit	Debit	Facility
01/11/2018 09:30 AM	Great Lakes Water	\$94.00		Payment	\$100.00	\$0.00	-\$1,848.50
01/11/2018 09:30 AM	Green Trucking	\$1,800.00		Payment	\$2,000.00	\$0.00	-\$1,848.50
01/11/2018 09:30 AM	iWaste Collector	\$1,100.00		Payment	\$1,500.00	\$0.00	-\$1,848.50
01/11/2018 09:29 AM	Aurora Pools, Inc.	\$394.60		Payment	\$400.00	\$0.00	\$1,751.50
01/11/2018 09:29 AM	HaulerMan	\$700.00		Payment	\$1,000.00	\$0.00	\$1,751.50
01/11/2018 09:28 AM	Water R Us	-\$3.30		Order	\$0.00	\$3.30	\$3,151.50
01/11/2018 09:27 AM	Green Trucking	-\$200.00		Order	\$0.00	\$200.00	\$3,148.20
01/11/2018 09:27 AM	HaulerMan	-\$300.00		Order	\$0.00	\$300.00	\$3,148.20
01/11/2018 09:27 AM	iWaste Collector	-\$400.00		Order	\$0.00	\$400.00	\$3,148.20
01/11/2018 09:26 AM	Great Lakes Water	-\$6.00		Order	\$0.00	\$6.00	\$2,248.20
01/11/2018 09:14 AM	Hawthorn Tanker, LLC	-\$775.00		Order	\$0.00	\$300.00	\$2,242.20
01/11/2018 09:14 AM	Dunsmoor Trucking	-\$1,103.50		Order	\$0.00	\$440.00	\$2,242.20
01/11/2018 09:13 AM	Just Us Water	-\$72.50		Order	\$0.00	\$30.00	\$1,502.20
01/11/2018 09:13 AM	Aurora Pools, Inc.	-\$5.40		Order	\$0.00	\$2.40	\$1,502.20
01/11/2018 09:12 AM	Dunsmoor Trucking	-\$663.50		Order	\$0.00	\$500.00	\$1,469.80
01/11/2018 09:12 AM	Hawthorn Tanker, LLC	-\$475.00		Order	\$0.00	\$275.00	\$1,469.80
01/11/2018 09:11 AM	Aurora Pools, Inc.	-\$3.00		Order	\$0.00	\$3.00	\$694.80
01/11/2018 09:10 AM	Water Transit, Inc.	-\$285.80		Order	\$0.00	\$2.40	\$691.80
01/11/2018 09:09 AM	Dunsmoor Trucking	-\$163.50		Order	\$0.00	\$165.00	\$689.40
01/11/2018 09:08 AM	Hawthorn Tanker, LLC	-\$200.00		Order	\$0.00	\$200.00	\$524.40

Figure 26: A grid in Portalogic

Each grid also populates the secondary navbar with a set of controls specific to that grid. If a grid has a control that it alone uses, it is described in its individual screen section. Here are the most common controls:

- **Back:** takes the main viewing pane to the previous screen
- **Refresh:** a button to manually refresh the data on the grid
- **Add:** leads to a screen where a new item can be created
- **Edit:** leads to a screen where changes can be made to the selected item
- **Delete:** removes the selected item from the grid. A confirmation prompt will appear before the item is deleted

Each grid is also accompanied by an “Export to Excel” button and an “Export to PDF” button. Press these buttons when you wish to save and/or view the data in these respective formats. Under each grid is a set of navigational controls that can be used to view multiple pages, or condense the data onto a single scrollable page.

Column Sorting

Items may be sorted by column by clicking on a column heading. When sorted this way, an arrow will appear indicating which direction its contents are being sorted (click again to sort the other direction, and once again to turn the sorting off). If sorting for a column is on, you may select up to four additional columns by which to sort by, in hierarchical order. With sorting for a column on, select additional columns. You will see a number appear next to the arrow indicating sort direction, the number being the column’s current hierarchy with 1 being the priority and 5 being the last. Sorting more than five columns will result in an error.

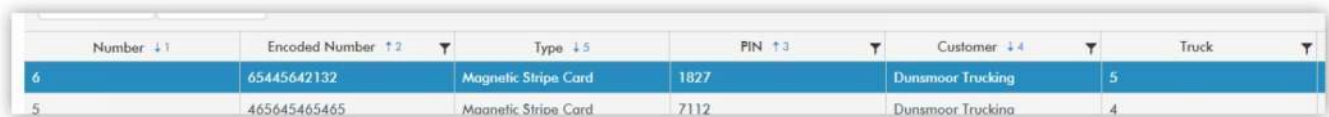

Number ↓ 1	Encoded Number ↑ 2	Type ↓ 5	PIN ↑ 3	Customer ↓ 4	Truck ↓ 5
6	65445642132	Magnetic Stripe Card	1827	Dunsmoor Trucking	5
5	465645465465	Magnetic Stripe Card	7112	Dunsmoor Trucking	4

Figure 27: Column Sorting Hierarchy

Filtering

Items may be filtered by clicking on a column’s filter icon. Set the operator and value to exactly your desired terms and click “Filter” to see your results. An additional operator and value may also be set to further narrow or expand your results. To clear the filter, click on the filter icon again and press the “Clear” button.

Order	Date	Customer	Station	Receipt	Truck
40	02/12/2018 - 8:31 AM	Green Trucking			0
41	02/12/2018 - 8:31 AM	Water Transit, Inc.			6
36	02/12/2018 - 8:30 AM	Water R Us			0
37	02/12/2018 - 8:30 AM	Great Lakes Water			0
38	02/12/2018 - 8:30 AM	iWaste Collector			0
39	02/12/2018 - 8:30 AM	Hawthorn Tanker, LLC			0
33	02/12/2018 - 8:29 AM	Dunsmoor Trucking			4
34	02/12/2018 - 8:29 AM	Aurora Pools, Inc.			10
35	02/12/2018 - 8:29 AM	HaulerMan	0	0	0
30	02/06/2018 - 8:19 AM	Green Trucking	0	0	0
31	02/06/2018 - 8:19 AM	Water R Us	0	0	0

Figure 28: Filter Screen

Note: When filtering by a specific date, setting the operator to “is equal to” will result in a search for items occurring at exactly midnight of the date you select. Instead, set the Operator to “Is after or equal to: (desired date)”, click the “And” option, and set the additional operator to “Is before: (day after desired date)”. For example, to see all orders for the month of July, select: Is after or equal to: 7/1/2021 AND Is before: 8/1/2021.

Grid Hotkeys

After making a selection within a grid, you may use the following hotkeys:

- Enter** sort by the selected column header
- Alt** + **Down** opens the selected column header’s filter menu
- Esc** closes the filter menu
- Ctrl** + **Left/Right** reorders the selected column with the previous/next column
- Tab** navigate through elements in the grid and filter screen (hold shift for reverse order)
- Arrow Keys** navigate over cells in the grid
- Page Up/Down** move to previous/next grid page
- Space** select the row with the currently highlighted cell
- Ctrl** + **Home/End** highlights the first/last cell in the grid
- Home/End** highlights the first/last cell in the current row

Sidebar Menu Screens

Clicking a link on the sidebar menu will navigate the main viewing pane to the selected screen. From here, you will have access to the screen's grid/forms and controls.

General Controls

Many grids utilize a few common controls. These are outlined below.

- **Add Item:** To add a new item, click the “Add” button in the top right corner. In the “Add (item name)” screen, fill out all required fields and any other fields as necessary. Then click “Create” in the top right corner, and a popup will alert you that an item was successfully created. The “Cancel” button will clear all fields in the form if needed. The main viewing pane will remain on this screen (allowing you to add new items in succession) until you navigate away or press the “Back” button.

Figure 29: Example Add Item Screen - Add Customer is shown here

- **Edit Item:** To edit an item, select it on the grid, and click the “Edit” button in the top right corner. Note that some fields are not editable once an item is created. Make changes as needed and click “Save” in the top right corner. A popup will alert you that the item was

successfully changed, and the main viewing pane will navigate back to the grid. The “Cancel” button will undo all changes prior to saving if needed.

Figure 30: Example Edit Item Screen - Edit Customer is shown here

- **Delete Item:** To delete an item, select it on the grid and click “Delete” in the top right corner. A “Delete Item Confirmation” popup will appear, select yes. A popup will alert you that an item was deleted, and the item will be removed from the grid.
- **Expand/ Collapse Section:** Form screens make use of collapsible section headers. A header in a blue bar is expanded, and a header in a white bar is collapsed. Click the bar to expand or collapse a section as needed.

Home Screen

After a successful login, Portalogic will Start, and the home screen will be displayed. You can always navigate back to this screen using the home button on the primary navbar. The home screen provides an overview of your stations’ performance and activity. From the dropdown in the top right, you may select “Today”, “Monthly”, or “Yearly” to adjust the data being displayed accordingly.

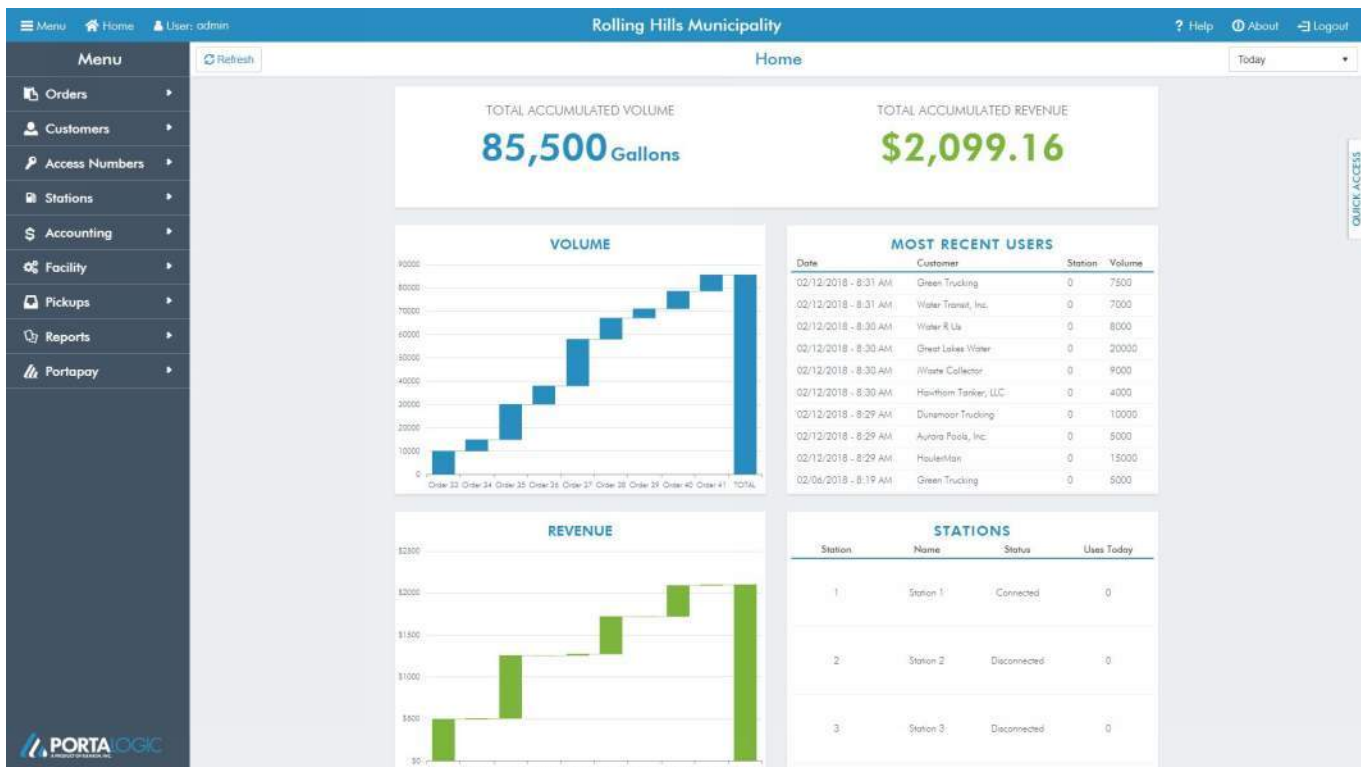

Figure 31: Portalogic Home Screen

Hovering over a chart entry will show the value of that entry. If the timeframe is set to “Today”, each entry is a single order, a single day for “Monthly”, and a single month for “Yearly”. The “Most Recent Users” grid will show the ten most recent users of your station(s). The “Stations” grid indicates the number of uses and the status of each of your stations.

Menu Navigation

Orders

The Orders Screen shows all the Orders received from stations or added manually. The grid columns include Order, Date, Customer Name, Station Number, Receipt Number, Truck Number, Product Type, Alarm Code, Duration, Volume, and Amount.

When adding or editing an order, if the cost for the selected product type has been set in “Facility → Product Type” the amount for the order will be calculated automatically.

The screenshot shows a web form titled "Order Information". At the top left, there is a timestamp "018 11:03 AM". In the center, the text "Cost/1000: \$50" and "Total: \$600.00" are displayed in blue. To the right, there is a "Volume" field with the value "12000". Below these, there is a dropdown menu on the left and a text input field labeled "Truck Driver Name" on the right.

Figure 32: The total for an order can be calculated automatically

Customers

The Customers Screen lists all customers that have been added to your system. The information shown here includes the customer’s Name, Account Number, Account Status, Sales this Month, and Current Balance.

Details: Clicking the “Details” button on the secondary navbar will open a window containing the selected customer’s name, address, contact information, account information, and details on the customer’s automatic billing settings.

Access Numbers

The Access Numbers Screen contains information regarding a customer’s access method to your station. The columns in this grid include Customer Name, Number (a generic number for identifying the access device), Type, PIN, Status, and Last Used.

Trucks

Once a customer is created, a truck can be assigned to that customer. Truck numbers are unique across all customers and may be assigned in the “Add Truck” screen. Pressing the “New” button next to the Truck Number field will set the number to the lowest unique truck number available. If you are assigning swipe cards to your haulers, the truck number will be the same as the swipe card number.

When adding or editing a truck, you can choose to bill the truck by capacity, apply a default product type to that truck, enable/disable the truck account (“Edit Truck” only), and set up a sample frequency for the truck if a sampler is set up. Account Active is enabled by default and will allow access to the water/waste station. Disabling it will prevent the truck’s associated card/login from working at the water/waste station.

Stations

The Stations Screen shows a list of all stations connected to Portalogic and the following information: Station, Name, Type, IP Address, Status, and Uses Today. When adding a station, ensure that you can first ping its IP address from the server hosting Portalogic (does not apply to cloud stations). When editing the station, you can create a custom schedule for your customers by clicking “Export To PDF” in the calendar section.

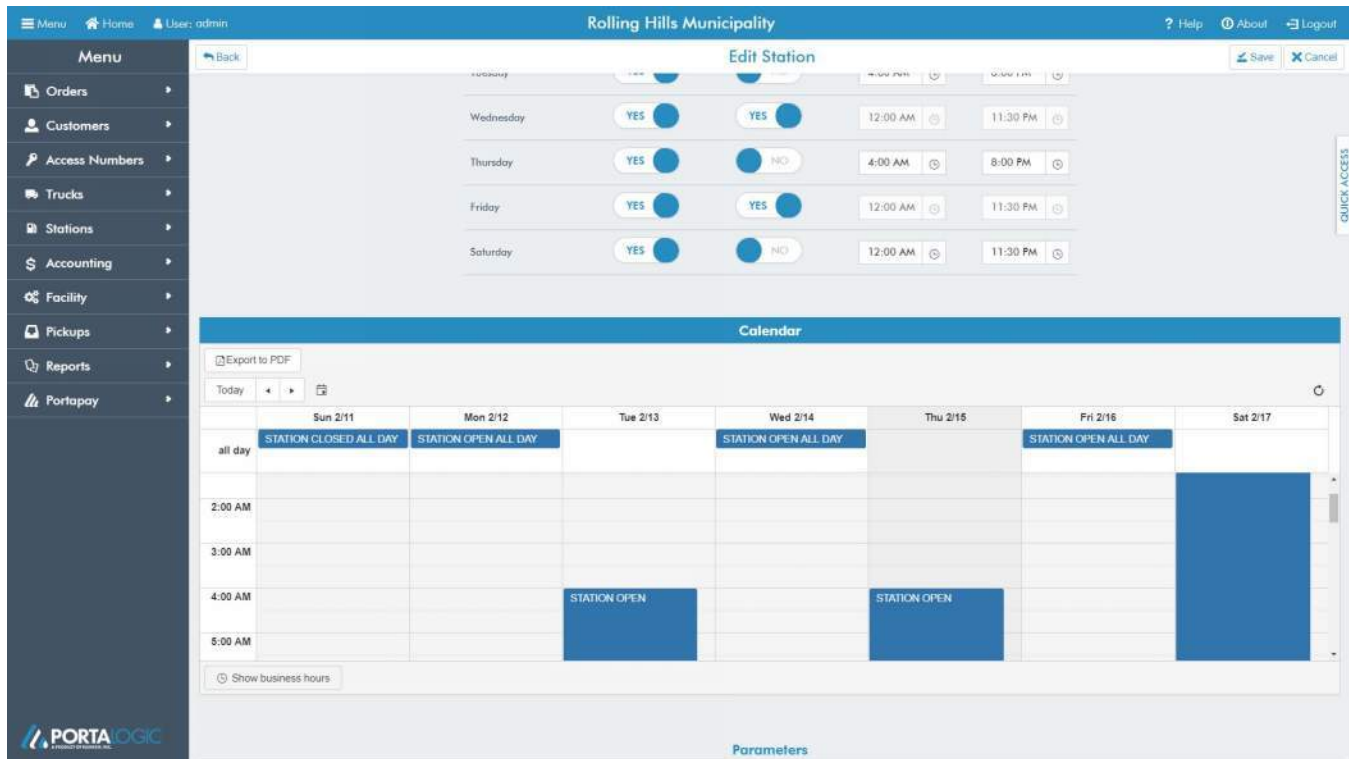

Figure 33: Set your schedule and Export to PDF to create a schedule for your customers

Should you need to access it, the station parameters may also be set in this screen.

Alarms: Clicking the “Alarms” button on the secondary navbar will display a grid containing all alarms that have occurred for the selected station.

Sync: The “Sync” button will sync relevant data and the date and time from your Portalogic server to your stations when pressed.

Accounting

This section contains two screens: Ledger and Payments/Expenses. Ledger contains a balance over time for each customer and the facility on a per-order basis. In Payments/ Expenses you can add a payment (Customer Debit) or expense (Customer Credit) for a customer’s account. Balance in the Ledger is the customer’s balance at midnight of the day the payment or expense was inserted.

Facility

This section contains information and settings for the Facility in general. See “Facility Menu” for more information.

Pickups

This section is only applicable for Waste Dump Stations using manifests. Pickups are the loads that comprise a manifest and are entered by the hauler while using a station. For every manifest, an order is created. When a manifest has pickups with different product types, the most expensive product type is used to calculate the total cost for the combined volume.

Reports

By making selections in this section, you may use Portalogic to generate custom reports. See “Chapter 5: Reports” for more information.

Facility Menu

Information

Within the Facility menu, clicking information will navigate the main pane to the Facility Information screen. here, you can set and save your facility name, contact and billing information, as well as view other information about your Portalogic setup.

Settings

In Facility → Settings, you may set an automatic data refresh interval (in seconds) and/or enable/ disable Automatic Data Refresh. Enabling Automatic Data Refresh allows Portalogic to refresh the information displayed in all grids and the home screen automatically each time your set interval elapses. Click “Save” in the top right corner to save your settings.

Email Setup

Clicking the Facility menu and selecting “Email Setup”, will display the email setup window. Setting Email Used to “Yes” will allow Portalogic to email an electronic copy of the receipt to the customer each time they use a station. To enable this feature for a customer, select the customer in the Customers grid, and click “Edit” in the top right corner. Under “Primary Contact”, set Email Receipts to “Yes”, and enter the customer’s email address. You may test an email address by clicking the “Test” button. Click “Save” to save your changes.

The Email Used switch will also allow Portalogic to email electronic copies of invoices to any addresses entered in the Invoice Recipients field (separate multiple email addresses with a comma). This feature is only available if automatic billing is enabled.

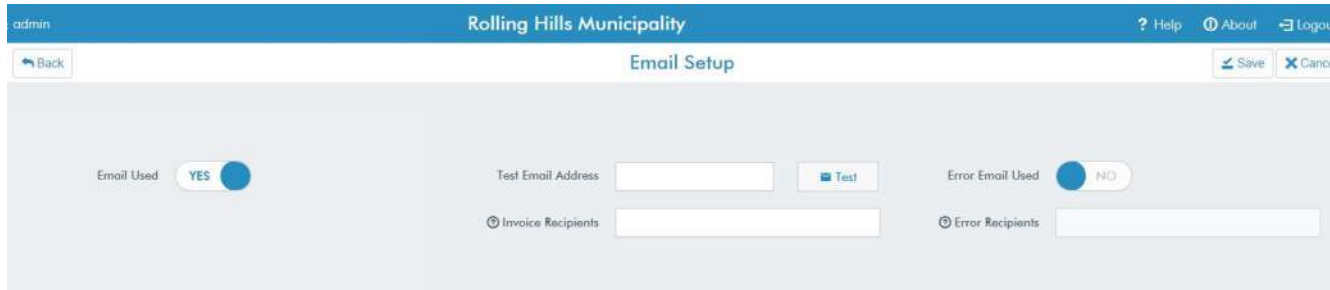

Figure 34: Portalogic Email Setup

Also in Email Setup, setting Error Email Used to “Yes” will enable the Error Recipients field and allow you to enter email addresses that will receive an email alert whenever an error occurs at a station (separate multiple email addresses with a comma). You may also test email addresses from this page by entering an email address in the Test Email Addresses field and clicking “Test”. Click “Save” to save your changes.

Product Types

Facility → Product Types displays a grid showing all product types and rates for your facility. You may add a new product type by clicking “Add” in the top right corner or edit existing product types by clicking “Edit”. From the Edit Product Type screen, you may set a future rate for a product and a date that the future rate will take effect. Rates are listed in cost/1,000.

Waste Generators

The Waste Generators grid lists all entered locations that your stations receive waste from. You may add new waste generators and edit existing waste generators by clicking the “Add” and “Edit” buttons in the top right corner. Within the Edit Waste Generators screen, you may enter specific customers who may select that generator as a manifest source while using your stations. Do so by entering the customers’ names in the Allowed Customers field under “Waste Information” (leaving this field empty allows all customers to select the waste generator as a manifest source). Click “Save” to save your changes.

Waste Information

Domestic Waste Non-Domestic *Default Waste Type Type 2

Non-Restaurant Restaurant Allowed Customers Enter Customer Name

Figure 35: Specify customers for a generator by entering their name in the Allowed Customers field

Users

The Users grid displays all user accounts that may login to Portalogic. Add new users by clicking “Add”, filling out the Add User form, and clicking “Create” in the top right corner.

The following are the access privileges of User roles:

- **Administrator:** Full access
- **Financial:** Cannot add/edit/delete Stations, edit Facility Information, edit Email Setup, or add/edit/delete Users
- **Operational:** Cannot add/edit/delete Stations, edit Facility Information, edit Email Setup, add/edit/delete Users, add/delete Orders, add/delete Payments
- **Read Only:** Cannot change data at all, but can view it
- All roles can generate reports.

Chapter 5: Reports

Generating Reports

Portallogic software can generate several types of reports including activity, billing, and revenue. All reports have date range selection fields to narrow down the information displayed. To generate a report, select “Reports” in the sidebar menu, select a sub-category, and finally your desired report. Reports can be printed or exported directly from Portallogic.

Activity Reports

Activity Reports display all customer trips to the water/waste station.

Note: Station 0 is listed anytime orders were manually added through Portallogic.

Activity by Station

The data is arranged by date and then by station. It includes the Time, Customer, Truck #, Receipt #, Alarm ID, Water/Waste ID, Entered Volume, Metered Volume, and Daily Total.

Activity by Customer

This report shows activity for a selected customer. You can choose to select a different customer from the customer name drop down. The data is organized by the date and time of each trip. It includes the Trip Date, Truck #, Receipt #, Alarm ID, Water/Waste Type, Volume, and Daily Total.

Activity by Truck

This report shows activity for a selected truck. You can choose to select a different truck from the truck number drop down. The data is organized by the date and time of each trip. It includes the Trip Date, Receipt #, Alarm ID, Water/Waste Type, Volume, and Daily Total.

Activity by Product Type

This report shows activity for a selected customer. The data is organized by the product type’s description name. It includes type description, total orders, and total volume for that type in the selected time frame.

Customer Statements

Customer Statements are Portalogic’s “Invoices”. There are three versions of this statement described in more detail below. This report may be used to assist in billing the customers. The user may enter a memo to the customer as well as a due date for payment. The rest of the report shows a summary of trips to the stations in the date range, followed by a detailed list of all of trips.

Note: The Customer Statement can be printed out for all customers by checking the switch labeled “All Customers” to generate reports more quickly. The file will be generated into a PDF file so that it may be saved or printed at any time.

The screenshot shows a web application interface for "Rolling Hills Municipality". The page title is "Cumulative Billing Statement". On the left, there is a navigation menu with options: "Customer", "Cumulative Billing Statement", "Term Billing Statement", and "Information Statement". The main content area contains several input fields: "Period" (set to "Custom"), "Start Date" (2/15/2018), "End Date" (2/15/2018), "All Customers" (a toggle switch set to "NO"), "Customer Name" (a dropdown menu with "Enter Customer Name" as the placeholder), and "Due Date" (2/15/2018). There are also fields for "Attention" and "Comments". At the top right, there are "Generate" and "Cancel" buttons. The user's name "admin" is visible in the top left corner.

Figure 36: Example Customer Statement screen - Cumulative Billing Statement is shown here

Cumulative Billing Statement

This statement allows you to select a payment due date to be included on the statement. Comments may be added and will appear immediately below the Summary section. Anything added in the Attention field will appear under the billing address. The address of your facility and customer are positioned to fit and align with a standard size (#10) windowed envelope. The statement lists the Water/Waste Type, Total Trips, Total Volume, Previous Balance, Current Balance, Invoice Number, and Account Number. The second page includes the “Account Adjustments” section where credit or interest is displayed and the “Account Debits” section.

By default, a single statement is created for the customer selected via the dropdown menu. To expedite the report generation process, Customer Statements can also be generated for all customers at once by setting All Customers to “Yes”.

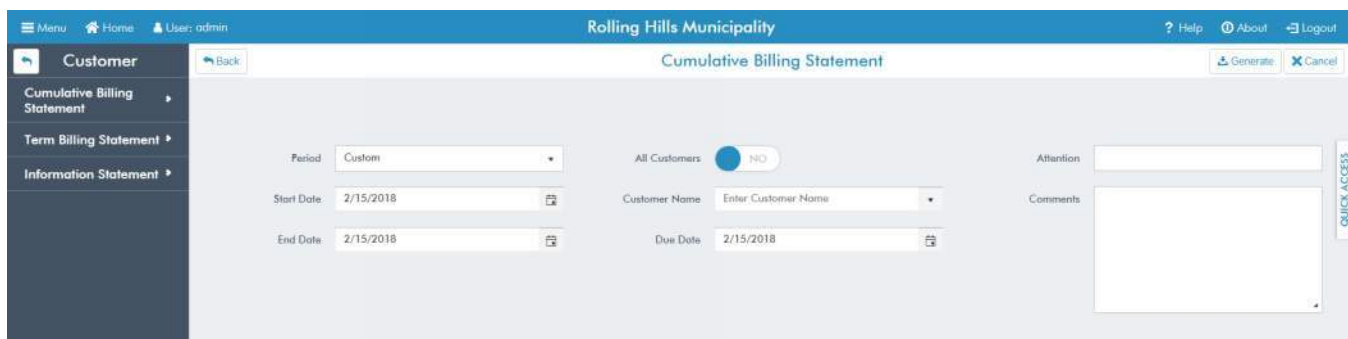
Term Billing Statement

This Statement is identical to the “Cumulative Billing Statement” except it does not include a

payment due date, previous balance, or an “Account Adjustments” section on the second page. This statement is comprised of payments, interest, and other account adjustments for the selected period, but it does not display them. Any account adjustments will automatically be added or subtracted to the “Statement Balance”.

Information Statement

This statement shows only activity and volume for the selected date range. No financial information is included.

Revenue Reports

Revenue by Customer – Summary

The data is arranged by customer. This report lists all Customers, their Total Trips, Total Volume, Total Revenue, and a Grand Total for each.

Revenue by Customer – Detail

This report is arranged by Customer and Account Number. It includes Trip Date, Receipt #, truck #, Product Type, Volume, and Sale Amount. The report displays Total Trips, Volume, and Revenue. If you have multiple stations, the report will show the station number for each order.

Revenue by Truck – Summary

The data is organized by truck number. It includes all trucks and lists the Truck Number, Total Trips, Total Volume, Total Revenue, and a Grand Total for each.

Revenue by Truck – Detail

This report only shows activity for a selected truck. The data is organized by the date and time of each trip. It includes the Trip Date, Receipt #, Product Type, Volume, and Daily Total. A Grand Total is provided for Trips, Volume, and Revenue.

Revenue by Water/Waste Type – Summary

This report summarizes the revenue by product type for orders within the selected date range. The report is arranged by product type and includes Total Trips, Total Volume, Balance, and a Grand Total for each.

Customer Truck List

This report lists all customers and trucks in the Portalogic database. Trucks are grouped by owning customer. This report lists the Truck Number, Vehicle Identification Number, Make/ Model, Contact, Phone Number, Cell Number, Sample Frequency, and Total Trucks.

Truck	VIN	Make/Model	Contact	Phone	Cell	Sample
Just Us Water						
2	7T8P28G01515473	Hercules-Benz Glau D	Pitts, Steven	(549)641-5648	(322)335-8649	0
3	1FAP96A220K242709	Ferrari Snaucroa Bralad	Bennett, Scott	(615)517-5167	(615)517-5167	0
8						0
8						0
						Total Trucks: 4
Dunsmoor Trucking						
4	1G8628L3C1194375	Lexus Znu Seared Phrog	Whitney, Christopher	(201)472-9152	(201)472-9152	0
5	1N0BR12E9WZ117635	Hummer Bronco De-Bus	Knowles, David	(817)768-6914	(817)768-6914	0
						Total Trucks: 2
Water Transit, Inc.						
6						0
						Total Trucks: 1
Aurora Pools, Inc.						
10			Griffa, Ric	(630)499-7080		0
						Total Trucks: 1
						Grand Total: 8 Trucks

Figure 37: Example generated Customer Truck List in print-preview

Chapter 6: Troubleshooting

Portalogic

Data is not syncing with the station

Search Windows for “Node.js Command Prompt” and run it as administrator. Run this command: “pm2 ls”. Ensure that the service “portalogic-data-service” shows, and its status is “online”. You can restart it by finding its id and replace it with # in this command: “pm2 restart #”.

Consult the portalogic-data-service log files in this directory for errors: C:\inetpub\wwwroot\logs.

Browsing OData shows 404 Error

URL: <http://localhost/PortOData4/Users?apikey=SG.fKTNqAgER4CI31NnK92XzA.gr2G8G7lpfw1M394XnIBZ0h> shows a 404 error and you cannot login to Portalogic 6. The possible solution (tested on Windows Server 2012 R2) is to open Server Manager → Manage → Add Roles or Features → Install the following:

- Application Server: Web Server (IIS) Support
- IIS Hostable Web Core

Retry the URL and consult the webpage for any detailed errors and check the Portalogic-OData.log file in this directory for errors: C:\inetpub\wwwroot\logs. You may need to remove the PortOData4 application from “Default Web Site” in IIS Manager and re-add it after installing the additional features before it will work.

Not Responding

Test the reception of the ePort within the FS-10 by pressing the Telemeter's RSSI button, as shown in Figure 6-1. The Telemeter's LEDs will light up indicating the signal strength. The card reader will also display CSQ: XX (signal strength) and CSQ: YY (Bit Error Rate). Use Table 1 to determine the quality of the signal. If the quality is below 'Good', the user may experience problems when using credit cards. Table 2 can be used for troubleshooting during normal operation.



Figure 38 - Telemeter's RSSI Button

Quality	Telemeter LEDs	CSQ: XX	CSQ: YY
Very Poor	none	00 to 07	Any value other than 00 for CSQ:YY indicates additional signal loss
Poor	Red	08 to 09	
Good	Red and Yellow	10 to 14	
Very Good	Red, Yellow, and Green	15 to 19	
Excellent	Red, Yellow, Green, and Blue	20 or greater	

Table 1 - ePort Signal Quality

RED	YELLOW	GREEN	BLUE	EXPLANATION
		blinking		In service - 1 second pulses (heartbeat)
blinking				Indicates device file system transfers (quick blink when saving)
		lit	lit	Establishing a cell connection (activated)
	lit			Pending transaction or settlement file
		lit		Initializing
			lit	Communications for Port 1 only (not shown when an ERROR)
lit	blinking			Disabled by VMC or no communications to VMC
lit	blink 2x			MDB busy or resetting

Table 2- ePort LED Status Codes

Troubleshooting

1. Currently Unable to Accept

- a) Press the “SERVICE” button on the G10-S Telemeter to display error codes on the Card Reader display.
- b) Code 1ID1 means vending machine has disabled the Card Reader.
- c) “Currently Unable to Accept” displayed on Card Reader: Same as 1ID1.
- d) Code 1IE0 means the G10-S is having wireless communications trouble.
- e) Code 1II1 means the G10-S is not communicating with the Vending Machine Controller (VMC)

2. Card Reader displays “Establishing Cell Connection” and reStarting

- a) Ensure antenna and antenna wire are in good condition, not broken, pinched or missing.
- b) Ensure that the antenna wire is not wrapped up in a coil as this will degrade signal.
- c) Try repositioning the antenna for better signal reception.

3. System has trouble communicating or authorizing cards reliably

- a) Check RSSI signal strength for a minimum reading of 12,00.
- b) If RSSI reading is below minimum recommended, see section above for antenna issues.

4. Card Reader has no display

- a) Check for disconnected, pinched, or broken cables.
 - b) If the G10-S Telemeter has a blinking green LED, replace the Card Reader.
 - c) If the G10-S Telemeter has no LED light activity, check for disconnected or broken MDB harness.
Another possibility is a failed G10-S Telemeter.
5. Card swipe or tap unable to be authorized
- a) Is the Card being used invalid, damaged, or expired?
 - b) Check for weak RSSI signal.
6. Card swipe or tap not detected by reader
- a) Ensure the Card Reader cable to the Telemeter is in good condition and connected.
 - b) Is the card being used invalid, damaged, or expired?
 - c) If the steps listed above are OK, replace the Card Reader.
7. Card Reader perpetually displays “Welcome” with steady green LED
- a) Ensure the Card Reader cable to the Telemeter is connected at both ends.

Further Troubleshooting

Contact USA Technologies Customer Service and have your ePort Telemeter number ready: (888) 561-4748.
customersupport@usatech.com

Printer

Malfunctioning

The Printer's status and possible error can be discerned by watching the number of times the status light blinks according to the chart below. The printer's status light is on the righthand side of its power cable.

STATUS LED		DESCRIPTION
-	OFF	DEVICE OFF
GREEN	ON	DEVICE ON: NO ERROR
GREEN COMMUNICATION STATUS	x 1	RECEIVE DATA
	x 2	PRINthead OVERHEATED
	x 3	PAPER END
	x 4	POWER SUPPLY VOLTAGE INCORRECT
	x 5	RECEPTION ERROR (PARITY, FRAME ERROR, OVERRUN ERROR)
	x 6	COMMAND NOT RECOGNIZED
	x 7	COMMAND RECEPTION TIME OUT
	x 8	INSPECTION DOOR OPEN ⁽¹⁾
	x 9	PAPER JAM
	x 10	LOW PAPER ⁽²⁾
GREEN UNRECOVERABLE ERROR	x 11	AUTOCUTTER ERROR ⁽³⁾

Figure 39 - Printer Status Codes

Chapter 7: Auto Backup

Prepare PowerShell

1. Enter “PowerShell” in the Windows search bar. In the results, right click “Windows PowerShell” and select “Run as administrator” from the context menu.

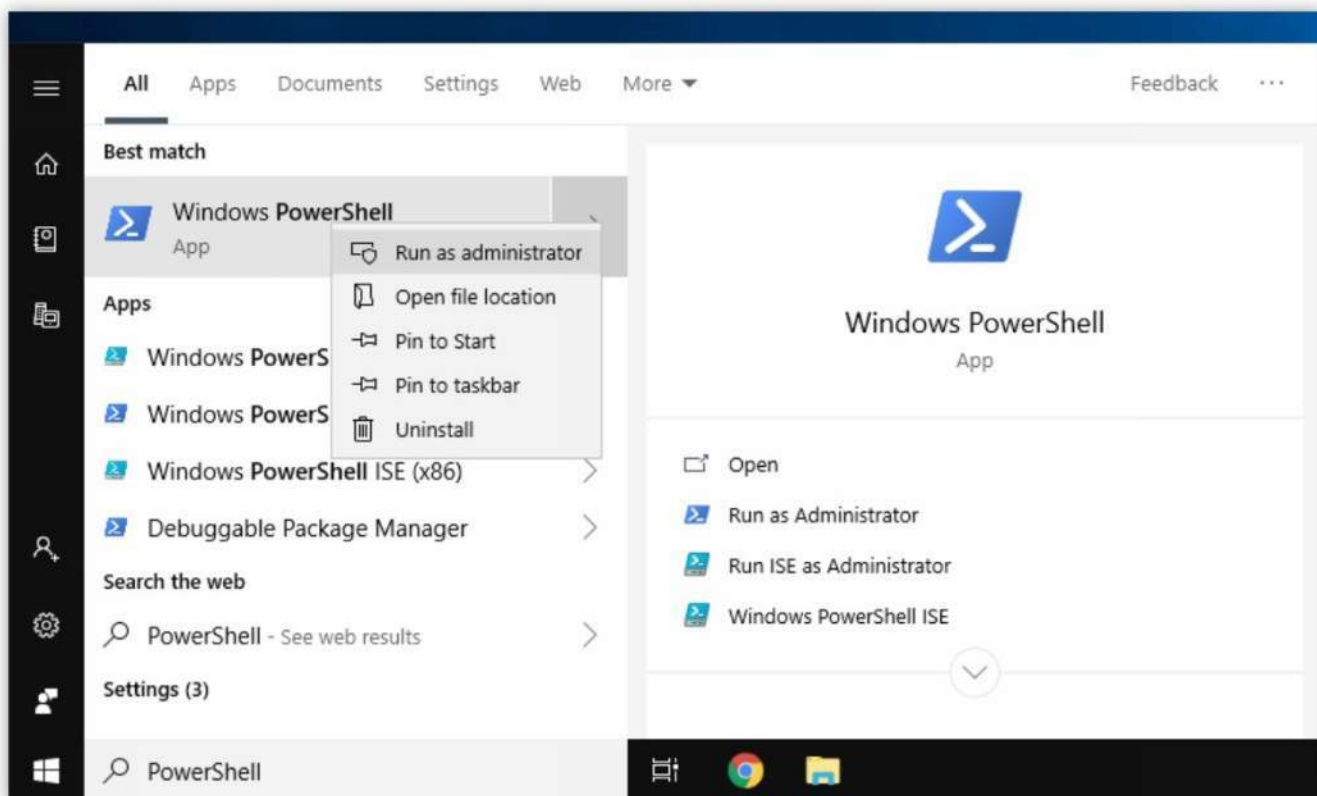

Figure 40: Run PowerShell as administrator

2. Once Windows PowerShell opens, type “set-executionpolicy remotesigned” and press Enter.
3. Select the “Yes” option by typing “Y” and pressing Enter.

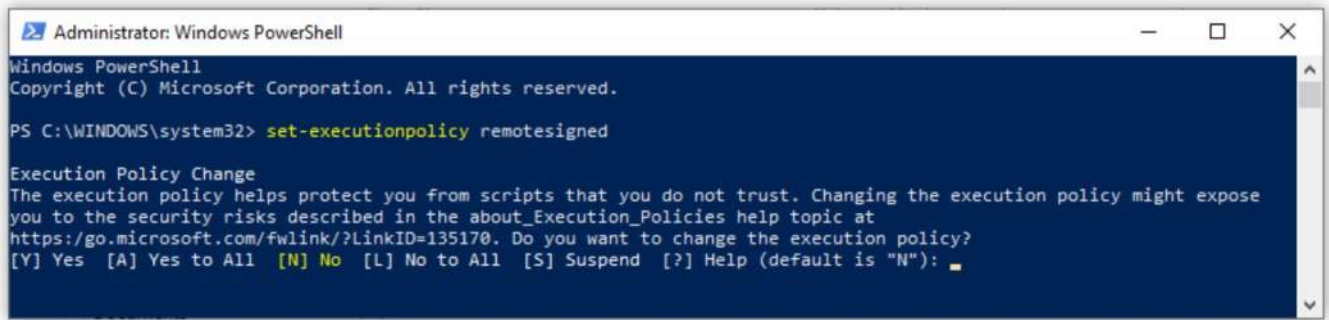

Figure 41: PowerShell Execution Policy Prompt

Create a Stored Procedure

1. From the provided files, create a copy of the “BackupApp” directory located in the “PortALogic6\Setup Files\Database Autobackup files” folder and place it in your “C:\temp\Elemech” directory (create this directory if it does not exist).
2. Start SQL Server Management Studio and select File → Open. Navigate to and open “C:\temp\Elemech\BackupApp\Scripts\SQL_Scripts\CreateStoredProc.sql”
3. Click Execute on the tool bar. If there is no error, a stored procure has been created.



Figure 42: Click Execute to test

4. In SQL Server Management Studio, select File → Open. Navigate to and open “C:\temp\Elemech\BackupApp\Scripts\SQL_Scripts\Full_DB_Backup.sql”
5. Click Execute on the tool bar (Figure 7-3). If there is no error, a stored procure has been created.
6. Test the new procedure by double-clicking the “Full_DB_Backup.sql” file located at “C:\temp\Elemech\BackupApp\Scripts\SQL_Scripts\Full_DB_Backup.sql”

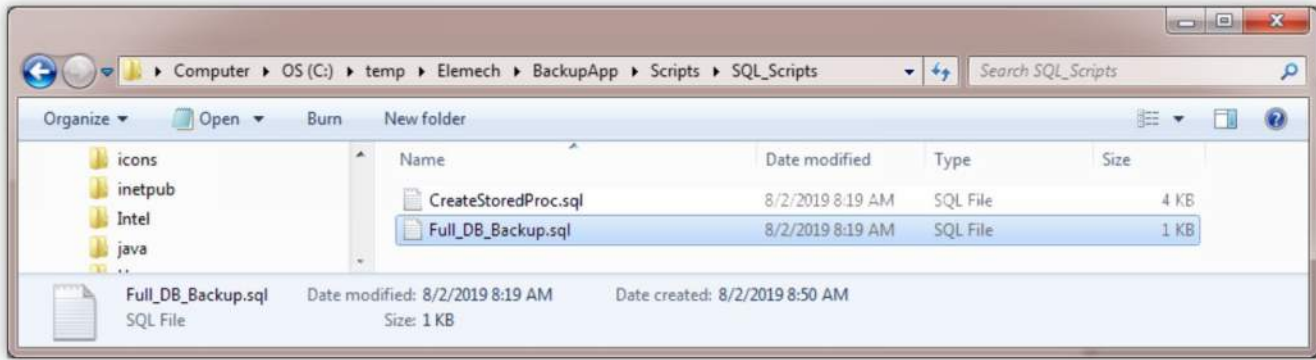

Figure 43 - Test Backup Procedure

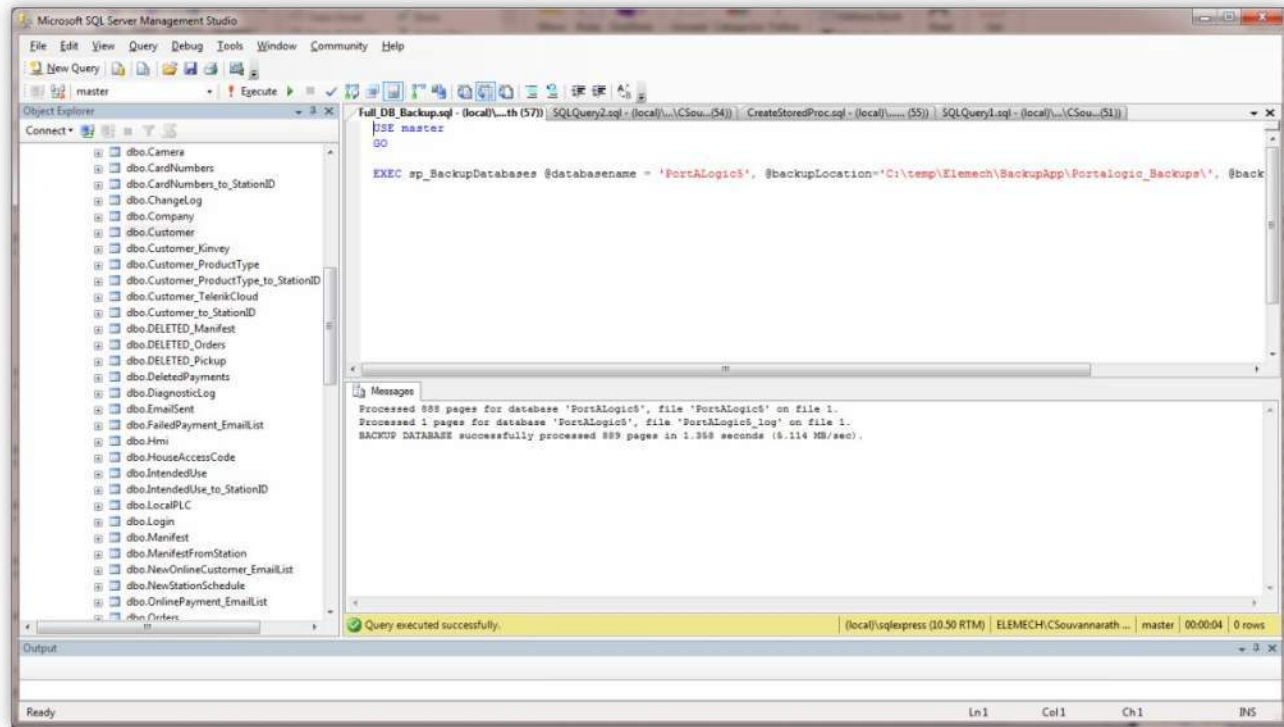

Figure 44: Test Backup Procedure

- It should run without error. Check your backup file at
 "C:\temp\Elemech\BackupApp\Portalogic_Backups\"

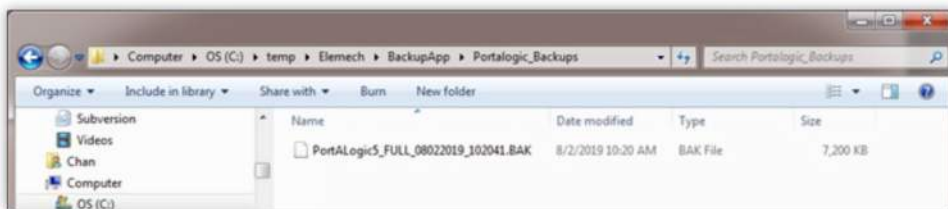
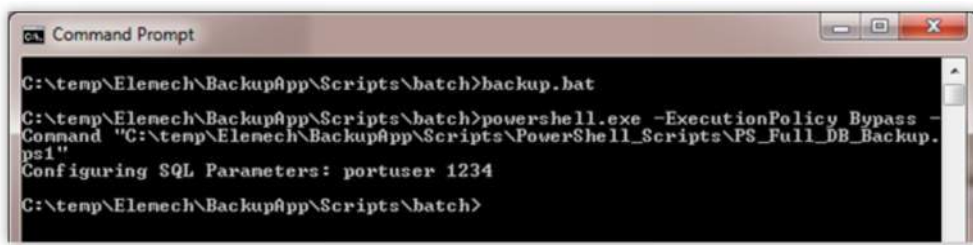

Figure 45: Backup File

Backup by Running Power script

1. Open Command Prompt and type “cd C:\temp\Elemech\BackupApp\Scripts\batch” and press Enter. Then type “backup.bat” and press Enter.



```
Command Prompt
C:\temp\Elemech\BackupApp\Scripts\batch>backup.bat
C:\temp\Elemech\BackupApp\Scripts\batch>powershell.exe -ExecutionPolicy Bypass -
Command "C:\temp\Elemech\BackupApp\Scripts\PowerShell_Scripts\PS_Full_DB_Backup.
ps1"
Configuring SQL Parameters: portuser 1234
C:\temp\Elemech\BackupApp\Scripts\batch>
```

Figure 46: Powerscript Backup

2. Check your new backup file at “C:\temp\Elemech\BackupApp\Portalogic_Backups\”

Schedule Auto Backup

Chapter 3 outlines how to schedule daily tasks in Windows. Please refer to those figures outlined below if further reference is needed.

1. Click  Start → Task Scheduler (see Figure 3-18).
2. Click “Create Basic Task...” → Name it “Elemech PortALogic Backup” → Next (see Figure 3-19).
3. Select “Daily” → Next (see Figure 3-20).
4. Set the time to around midnight → Next (see Figure 3-21).
5. Select “Start a program” → Next (see Figure 3.22).
6. Browse → C:\temp\Elemech\BackupApp\Scripts\batch\backup.bat → Next → Finish (see Figure 3-23).
7. Right-click on “Elemech PortALogic Backup” → Properties (see Figure 3-24)
8. Select “Run whether user is logged on or not” → OK (see Figure 3-25).
9. Enter your password → OK.

Manual Backup

Setting Up a Manual Back Up

To setup a Portalogic Database backup manually, follow the steps below:

1. Click  Start → Search and open “SQL Server Management Studio”
2. Expand “(Local)\SQLEXPRESS”
3. Expand “Databases”
4. Right click on “Portalogic5”
5. Select “Tasks”
6. Select “Back Up...”
7. In the “Back Up Database – Portalogic5” window there is a “Select a Page” panel to the left → Click on “Media Options”
 - a) **NOTE:** Under “Overwrite media”, “Back up to the existing media set” should be checked.
 - b) Change the “Append to the existing backup set” to “Overwrite all existing backup sets” by clicking on it → OK

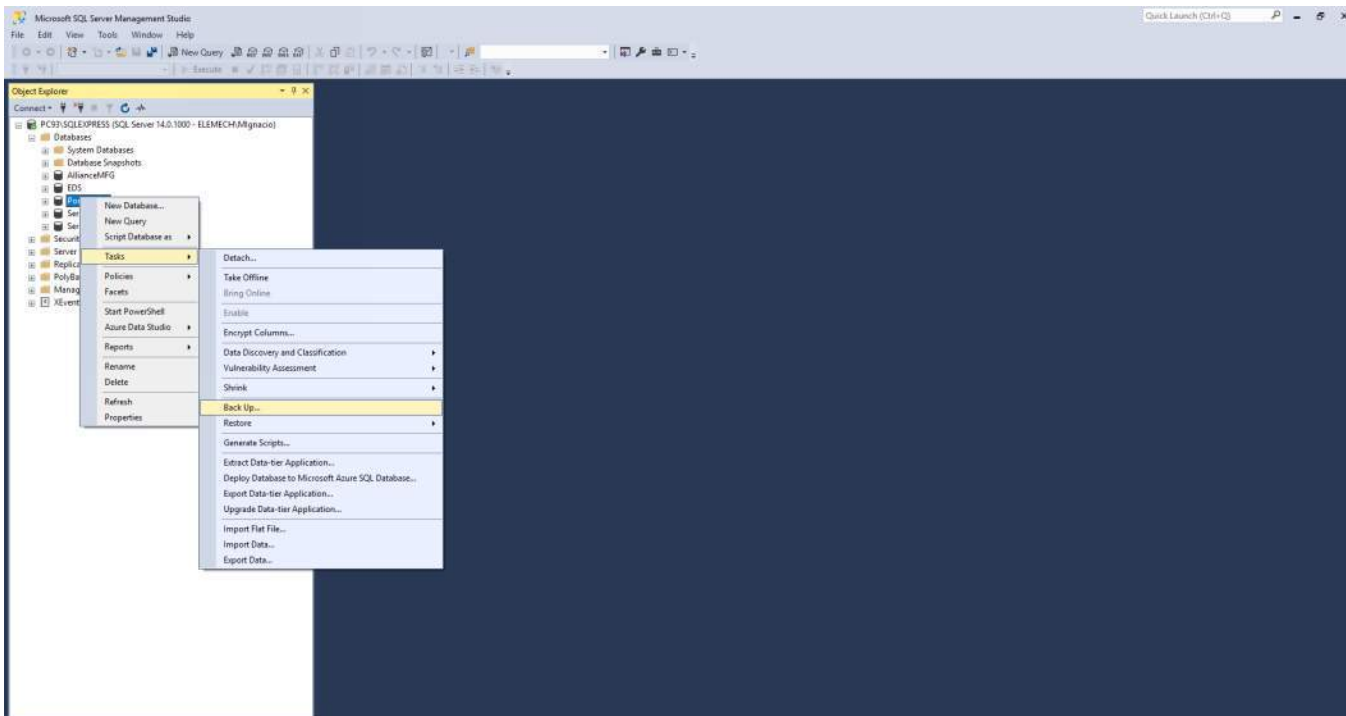

Figure 47: Drill Down of Portalogic 5 for Manual Backup

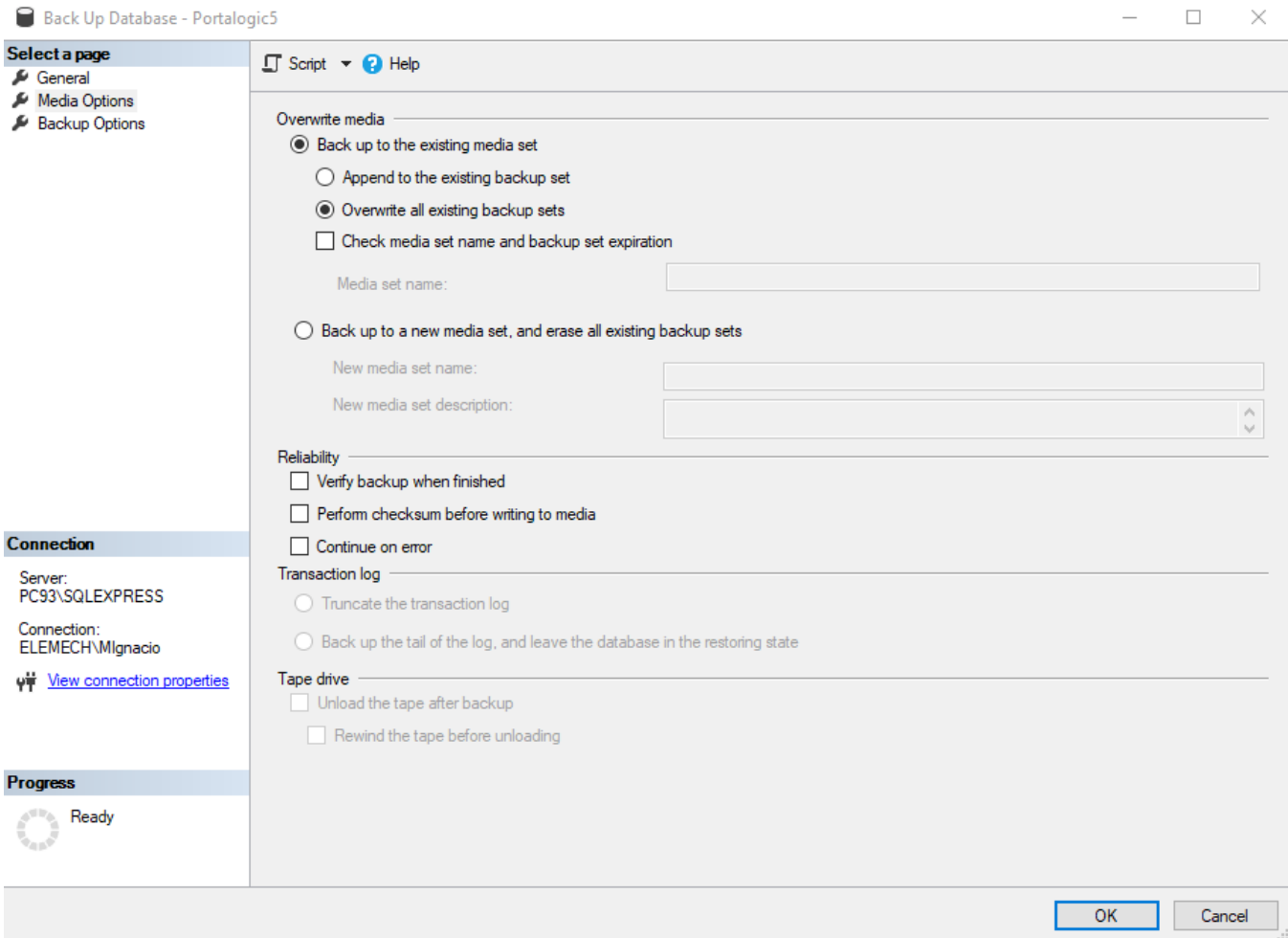

Figure 48: Backup Database - Portalogic 5 Window

Chapter 8: Diagrams

Figure 1: New SQL Server Installation.....	6
Figure 2: SQL Server Instance Configuration	7
Figure 3: SQL Server Mixed Mode	8
Figure 4: SQL Management Studio Installation	9
Figure 5: SQL Management Studio Feature Selection	10
Figure 6: SQL Management Studio execute database script.....	11
Figure 7: Setting Up Cloud Job Number.....	13
Figure 8: TelerikCloudJobNumber Tab	13
Figure 9: SQL Management Studio new user	14
Figure 10: SQL Management Studio database user	15
Figure 11: ASP.NET and IIS Installation	17
Figure 12: Internet Information Services – drilldown.....	18
Figure 13: Internet Information Services - OData Website	18
Figure 14: Internet Information Services - Browse WCF	19
Figure 15: OData successfully hosted	19
Figure 16: OData Users Table Test.....	20
Figure 17: Internet Information Services - add Portalogic6	20
Figure 18: Internet Information Services - Application Pool	21
Figure 19: ASP.NET Web API Successful	22
Figure 20: Windows Firewall - Inbound Rules	22
Figure 21: Windows Firewall - Port 84, 85 Opened	23
Figure 31: Outlook Test Email Configuration.....	24
Figure 32: Portalogic Login	26
Figure 33 - Portalogic Database Design	27
Figure 34: Navigation Areas	28
Figure 35: A grid in Portalogic.....	29
Figure 36: Column Sorting Hierarchy.....	30
Figure 37: Filter Screen	31
Figure 38: Example Add Item Screen - Add Customer is shown here	32

Figure 39: Example Edit Item Screen - Edit Customer is shown here..... 33

Figure 40: Portalogic Home Screen..... 34

Figure 41: The total for an order can be calculated automatically 35

Figure 42: Set your schedule and Export to PDF to create a schedule for your customers..... 36

Figure 43: Portalogic Email Setup 38

Figure 44: Specify customers for a generator by entering their name in the Allowed Customers field..... 39

Figure 45: Example Customer Statement screen - Cumulative Billing Statement is shown here..... 41

Figure 46: Example generated Customer Truck List in print-preview 43

Figure 47 - Telemeter's RSSI Button 45

Figure 48 - Printer Status Codes 48

Figure 49: Run PowerShell as administrator..... 49

Figure 50: PowerShell Execution Policy Prompt..... 50

Figure 51: Click Execute to test..... 50

Figure 52 - Test Backup Procedure 51

Figure 53: Test Backup Procedure 51

Figure 54: Backup File 51

Figure 55: Powerscript Backup 52

Figure 56: Drill Down of Portalogic 5 for Manual Backup 53

Figure 57: Backup Database - Portalogic 5 Window..... 54

Chapter 9: Technical Support

For Portalogic technical support, contact:

EleMech Inc.

2275 White Oak Circle

Aurora, IL 60502

Phone: (630) 499-7080

Business Hours : Monday – Friday, 8 AM – 4 :30 PM Central Time

Email: Portalogic.Support@elemech.com

Please include your job number and version of Portalogic 6 in the email.

www.portalogic.info/support.html

**ATTACHMENT 3:
LATEST DAVIS-BACON
WAGE DET.**

Superseded General Decision Number: IN20240006

State: Indiana

Construction Types: Heavy and Highway

Counties: Adams, Allen, Bartholomew, Benton, Blackford, Boone, Brown, Carroll, Cass, Clark, Clay, Clinton, Crawford, Daviess, Dearborn, Decatur, DeKalb, Delaware, Dubois, Elkhart, Fayette, Floyd, Fountain, Franklin, Fulton, Gibson, Grant, Greene, Hamilton, Hancock, Harrison, Hendricks, Henry, Howard, Huntington, Jackson, Jasper, Jay, Jefferson, Jennings, Johnson, Knox, Kosciusko, Lagrange, Lawrence, Madison, Marion, Marshall, Martin, Miami, Monroe, Montgomery, Morgan, Newton, Noble, Ohio, Orange, Owen, Parke, Perry, Pike, Posey, Pulaski, Putnam, Randolph, Ripley, Rush, Scott, Shelby, Spencer, Starke, Steuben, Sullivan, Switzerland, Tippecanoe, Tipton, Union, Vanderburgh, Vermillion, Vigo, Wabash, Warren, Warrick, Washington, Wayne, Wells, White and Whitley Counties in Indiana.

* EXCEPT LAKE, LAPORTE, PORTER AND ST. JOSEPH COUNTIES HEAVY AND HIGHWAY CONSTRUCTION PROJECTS

Note: Contracts subject to the Davis-Bacon Act are generally required to pay at least the applicable minimum wage rate required under Executive Order 14026 or Executive Order 13658. Please note that these Executive Orders apply to covered contracts entered into by the federal government that are subject to the Davis-Bacon Act itself, but do not apply to contracts subject only to the Davis-Bacon Related Acts, including those set forth at 29 CFR 5.1(a)(1).

If the contract is entered into on or after January 30, 2022, or the contract is renewed or extended (e.g., an option is exercised) on or after January 30, 2022:	. Executive Order 14026 generally applies to the contract. . The contractor must pay all covered workers at least \$17.75 per hour (or the applicable wage rate listed on this wage determination, if it is higher) for all hours spent performing on the contract in 2025.
If the contract was awarded on or between January 1, 2015 and January 29, 2022, and the contract is not renewed or extended on or after January 30, 2022:	. Executive Order 13658 generally applies to the contract. . The contractor must pay all covered workers at least \$13.30 per hour (or the applicable wage rate listed on this wage determination, if it is higher) for all hours spent performing on that contract in 2025.

The applicable Executive Order minimum wage rate will be adjusted annually. If this contract is covered by one of the

Executive Orders and a classification considered necessary for performance of work on the contract does not appear on this wage determination, the contractor must still submit a conformance request.

Additional information on contractor requirements and worker protections under the Executive Orders is available at <http://www.dol.gov/whd/govcontracts>.

Modification Number	Publication Date
0	01/03/2025
1	01/17/2025
2	01/31/2025
3	02/14/2025

ASBE0008-004 03/01/2024

DEARBORN, FAYETTE, FRANKLIN, OHIO, RIPLEY SWITZERLAND AND UNION COUNTIES

	Rates	Fringes
Asbestos Workers/Insulator (Includes application of all insulating materials, protective coverings, coatings & finishings to all types of mechanical systems).....	\$ 34.23	21.94
HAZARDOUS MATERIAL HANDLER (Includes preparation, wettings, stripping, removal, scrapping, vacuuming, bagging & disposing of all insulation materials, whether they contain asbestos or not, from mechanical systems).....	\$ 25.00	13.70

ASBE0017-008 06/01/2024

NEWTON COUNTY:

	Rates	Fringes
ASBESTOS WORKER/HEAT & FROST INSULATOR.....	\$ 55.02	35.75
HAZARDOUS MATERIAL HANDLER (INCLUDES PREPARATION, WETTING, STRIPPING REMOVAL SCRAPPING, VACUUMING, BAGGING AND DISPOSAL OF ALL INSULATION MATERIALS, WHETHER THEY CONTAIN ASBESTOS OR NOT, FROM MECHAINCAL SYSTEMS).....	\$ 44.02	32.76

ASBE0018-005 06/01/2024

BROWN, BARTHOLOMEW, BENTON, BOONE, CARROLL, CASS, CLAY, CLINTON, DECATUR, DELAWARE, ELKHART. FOUNTAIN, FULTON, GREENE, HAMILTON, HANCOCK, HENDRICKS, HENRY, HOWARD, JASPER, JOHNSON, KOSCIUSKO, LAGRANGE, MARSHALL, MADISON, MARION, MONROE, MONTGOMERY, MORGAN, OWEN, PARKE, PULASKI, PUTNAM, RUSH, SHELBY, STARKE, TIPPECANOE, TIPTON, VERMILLION, VIGO, WARREN and WHITE Counties

	Rates	Fringes
ASBESTOS WORKER/HEAT & FROST INSULATOR (includes application of all insulating materials, protective coverings, coatings and finishings to all types of mechanical systems).....	\$ 38.55	23.53
HAZARDOUS MATERIAL HANDLER (includes preparation, wettings, stripping, removal, scrapping, vacuuming, bagging & disposing of all insulation materials, whether they contain asbestos or not, from mechanical systems).....	\$ 23.00	14.40

ASBE0037-004 04/02/2024		

DAVISS, DUBOIS, GIBSON, KNOX, MARTIN, PIKE, POSEY, SPENCER,
SULLIVAN, VANDERBURGH AND WARRICK COUNTIES

	Rates	Fringes
ASBESTOS WORKER/HEAT & FROST INSULATOR (includes application of all insulating materials protective coverings, coatings an finishes to all types of mechanical systems. Also the application of firestopping, material openings and penetrations in walls, floors, ceilings, curtain walls and all lead abatement.)...\$	27.19	22.06
HAZARDOUS MATERIAL HANDLER (Includes preparation, wetting, stripping, removal, scrapping, vacuuming, bagging and disposing of all insulation materials, whether they contain asbestos or not, from mechanical systems).....	\$ 33.44	21.84

ASBE0041-002 07/01/2024		

ADAMS, ALLEN, BLACKFORD, DE KALB, GRANT, HUNTINGTON, JAY,
MIAMI, NOBLE, STEUBEN, WABASH, WELLS AND WHITLEY COUNTIES:

	Rates	Fringes
ASBESTOS WORKER/HEAT & FROST INSULATOR (includes application of all insulating materials, protective coverings, coatings and finishings to all types of mechanical systems).....	\$ 35.10	19.39
HAZARDOUS MATERIAL HANDLER		

(includes preparation, wettings, stripping, removal, scrapping, vaccuming, bagging & disposing of all insulation materials, whether they contain asbestos or not, from mechanical systems).....\$ 35.10 19.39

ASBE0051-003 03/01/2024

CLARK, CRAWFORD, FLOYD, HARRISON, JACKSON, JEFFERSON, JENNINGS, LAWRENCE, ORANGE, PERRY, SCOTT, and WASHINGTON Counties

Rates Fringes

ASBESTOS WORKER/HEAT & FROST INSULATOR (Includes application of all insulating materials, protective coverings, coatings and finishings to all types of mechanical systems).....\$ 29.31 18.47
HAZARDOUS MATERIAL HANDLER (includes preparation, wettings, stripping, removal, scrapping, vaccuming, bagging & disposing of all insulation materials, whether they contain asbestos or not, from mechanical systems).....\$ 19.80 13.30

ASBE0079-002 07/01/2024

RANDOLPH AND WAYNE COUNTIES

Rates Fringes

ASBESTOS WORKER/HEAT & FROST INSULATOR (Includes application of all insulating materials, protective coverings, coatings & finishings to all types of mechanical systems).....\$ 38.56 18.70
HAZARDOUS MATERIAL HANDLER (Includes preparation, wetting, stripping, removal, scrapping, vacuuming, bagging & disposing of all insulation materials, whether they contain asbestos or not, from mechanical systems).....\$ 38.56 18.70

BRIN0003-001 06/01/2023

INDIANAPOLIS
BOONE, HANCOCK, HENDRICKS, JOHNSON, MARION, MONTGOMERY, MORGAN and SHELBY COUNTIES

Rates Fringes

Bricklayer, Stone Mason, Pointer, Caulking.....\$ 36.24 17.39

TERRAZZO FINISHER.....	\$ 23.38	13.15
TERRAZZO WORKER/SETTER.....	\$ 36.38	17.24
Tile & Marble Finisher.....	\$ 24.33	13.16
Tile, Marble Setter.....	\$ 35.63	17.23

BRIN0004-004 06/01/2024

FORT WAYNE
ADAMS, ALLEN, DEKALB, HUNTINGTON, NOBLE, STEUBEN, WELLS AND
WHITLEY COUNTIES:

	Rates	Fringes
BRICKLAYER (STONE MASON, MARBLE MASONS, POINTER, CLEANER, AND CAULKER).....	\$ 35.00	21.60
Terrazzo Grinder Finisher.....	\$ 31.00	17.89
Terrazzo Worker Mechanic.....	\$ 36.30	22.04
Tile Setter & Marble Mason Mechanic.....	\$ 31.55	19.08
Tile, Marble & Terrazzo Finisher.....	\$ 31.55	19.08

BRIN0004-005 06/01/2024

CRAWFORD, DUBOIS, PERRY, POSEY, SPENCER, VANDERBURGH, and
WARRICK Counties

	Rates	Fringes
BRICKLAYER.....	\$ 35.34	21.72
TILE FINISHER.....	\$ 29.08	17.32
TILE SETTER.....	\$ 29.08	17.32

BRIN0004-009 06/01/2024

BARTHOLOMEW, BROWN, DEARBORN, DECATUR, JENNINGS, MONROE, OHIO,
OWENS, RIPLEY and SWITZERLAND COUNTIES

	Rates	Fringes
Bricklayer, Stonemason.....	\$ 35.21	18.19
TERRAZZO FINISHER.....	\$ 25.33	14.19
TERRAZZO WORKER/SETTER.....	\$ 37.97	18.06
Tile & Marble Finisher.....	\$ 25.33	14.19
Tile, Marble Setter.....	\$ 37.22	18.05

BRIN0004-010 06/01/2024

CLARK, FLOYD, and HARRISON Counties

	Rates	Fringes
BRICKLAYER BRICKLAYERS, STONEMASONS AND CEMENT MASONS.....	\$ 33.70	16.57

BRIN0004-015 06/01/2024

TERRE HAUTE
CLAY, DAVIESS, GIBSON, GREENE, KNOX, MARTIN, PARKE, PIKE,
PUTNAM, SULLIVAN, VERMILLION and VIGO COUNTIES

	Rates	Fringes
BRICKLAYER		
BRICKLAYERS, STONE MASONS and POINTER/ CLEANER/CAULKER.....	\$ 38.16	18.22
CEMENT MASON (Greene and Sullivan Counties).....	\$ 27.78	11.02
CEMENT MASON (REMAINING COUNTIES).....	\$ 37.16	18.22
TERRAZO FINISHER.....	\$ 25.33	14.19
TERRAZO WORKER.....	\$ 37.97	18.06
TILE LAYER, MARBLE MASON, MOSAIC WORKER.....	\$ 38.16	18.22

BRIN0004-016 06/01/2024

MUNCIE
BLACKFORD, DELAWARE, FAYETTE, FRANKLIN, HAMILTON, HENRY, JAY,
MADISON, RANDOLPH, RUSH, TIPTON, UNION and WAYNE COUNTIES

	Rates	Fringes
Bricklayer, Stonemason, Pointer, Caulker & Cleaner.....	\$ 35.83	20.89
TERRAZO FINISHER.....	\$ 25.33	14.19
TERRAZO WORKER/SETTER.....	\$ 37.97	18.06
Tile & Marble Finisher.....	\$ 25.33	14.19
Tile & Marble Setter; Mosaic Worker.....	\$ 35.83	20.89

BRIN0006-001 06/01/2023

JASPER, NEWTON & STARKE COUNTIES

	Rates	Fringes
BRICKLAYER (Including Stonemason, and Pointer, Caulker & Cleaner).....	\$ 42.05	28.22
Tile, Marble & Terrazzo Worker...\$	42.05	28.22

BRIN0011-001 06/01/2023

LAFAYETTE
BENTON, CARROLL, CLINTON, FOUNTAIN, TIPPECANOE, WARREN and
WHITE COUNTIES

	Rates	Fringes
Bricklayer, Stonemason, Pointer, Caulker & Cleaner.....	\$ 33.75	20.12
TERRAZO FINISHER.....	\$ 23.38	13.15
TERRAZO WORKER/SETTER.....	\$ 36.38	17.24
Tile & Marble Finisher.....	\$ 24.33	13.16
Tile & Marble Setter; Mosaic Worker.....	\$ 35.63	17.23

BRIN0018-002 06/01/2023

CASS, ELKHART, FULTON, GRANT, HOWARD, KOSCUISKO, LAGRANGE,

MARSHALL, MIAMI, PULASKI, WABASH

	Rates	Fringes
Bricklayer, Caulker, Cleaner, Pointer.....	\$ 34.00	19.71

CARP0002-023 04/01/2024		

DEARBORN, JACKSON, JENNINGS, OHIO, RIPLEY AND SWITZERLAND
COUNTIES

	Rates	Fringes
CARPENTER.....	\$ 29.28	27.90

CARP0133-001 04/01/2024		

BOONE, CLAY, FOUNTAIN, MONROE, MONTGOMERY, MORGAN, OWEN,
PARKE, PUTNAM, VERMILLION AND VIGO COUNTIES

	Rates	Fringes
CARPENTER.....	\$ 32.93	24.91

CARP0133-003 04/01/2024		

HAMILTON, HANCOCK, HENDRICKS, JOHNSON (Townships of Clark, Camp
Atterbury north of Hospital Road, Pleasant, White River), and
MARION Counties

	Rates	Fringes
CARPENTER.....	\$ 34.04	24.91

CARP0175-004 04/01/2024		

CLARK, FLOYD, HARRISON, JEFFERSON, SCOTT AND WASHINGTON COUNTIES

	Rates	Fringes
CARPENTER.....	\$ 28.71	28.47

CARP0215-002 04/01/2024		

BENTON, CARROLL, CLINTON, PULASKI, TIPPECANOE, WARREN AND WHITE
COUNTIES

	Rates	Fringes
CARPENTER.....	\$ 33.43	24.37

CARP0224-011 04/01/2024		

CRAWFORD, DUBOIS, PERRY, PIKE, POSEY, SPENCER, VANDERBURGH AND
WARRICK COUNTIES:

Rates	Fringes
-------	---------

CARPENTER.....\$ 28.78 28.40

CARP0224-012 04/01/2024

DAVISS, GIBSON, GREENE, KNOX, LAWRENCE, MARTIN, ORANGE AND
SULLIVAN COUNTIES:

 Rates Fringes

CARPENTER.....\$ 29.13 28.45

CARP0232-003 04/01/2024

ALLEN, DEKALB, LAGRANGE, NOBLE, STEUBEN and WHITLEY COUNTIES

 Rates Fringes

CARPENTER.....\$ 32.10 25.04

CARP0301-001 04/01/2024

BARTHOLOMEW, BROWN,(Camp Atterbury south of Hospital Road),
DECATUR, FRANKLIN, JOHNSON (Townships of Blue River, Franklin,
Hensley, Needham, Nineveh, Union) , RUSH AND SHELBY COUNTIES

 Rates Fringes

CARPENTER.....\$ 32.49 24.91

CARP0413-003 04/01/2024

ADAMS, CASS, ELKHART, FULTON, GRANT, HOWARD, HUNTINGTON,
KOSCIUSKO, MARSHALL, MIAMI, TIPTON, WABASH AND WELLS COUNTIES:

 Rates Fringes

CARPENTER.....\$ 32.42 24.87

CARP0999-001 06/01/2024

JASPER, NEWTON, AND STARKE COUNTIES

 Rates Fringes

CARPENTER.....\$ 43.58 34.68

CARP1016-001 04/01/2024

BLACKFORD, DELAWARE, FAYETTE, HENRY, JAY, MADISON, RANDOLPH,
UNION AND WAYNE COUNTIES

 Rates Fringes

CARPENTER.....\$ 32.69 24.91

CARP1076-004 04/01/2016

HAMILTON and MARION Counties, and the following Townships in
JOHNSON County: Camp Atterbury (North of Hospital Rd.), Clark,
Pleasant, and White River

	Rates	Fringes
MILLWRIGHT.....	\$ 26.81	19.28

CARP1076-005 06/01/2017		

JASPER, NEWTON, PULASKI, and STARKE Counties

	Rates	Fringes
MILLWRIGHT.....	\$ 37.66	26.42

CARP1076-006 06/01/2018		

BARTHOLOMEW, BLACKFORD, BOONE, BROWN, CLAY, DECATUR, DELAWARE, FAYETTE, FOUNTAIN, FRANKLIN, HAMILTON, HANCOCK, HENDRICKS, HENRY, JAY, JOHNSON, MADISON, MARION, MONROE, MONTGOMERY, MORGAN, OWEN, PARKE, PUTNAM, RANDOLPH, RUSH, SHELBY, UNION, VERMILLION, VIGO, AND WAYNE COUNTIES

	Rates	Fringes
MILLWRIGHT.....	\$ 28.18	22.39

CARP1080-001 04/01/2021		

GIBSON, GREENE, POSEY, SULLIVAN, VANDERBURGH and WARRICK COUNTIES

	Rates	Fringes
MILLWRIGHT		
ZONE 1		
POSEY, VANDERBURGH and		
WARRICK COUNTIES.....	\$ 30.92	24.83
ZONE 2		
GIBSON, GREENE AND		
SULLIVAN COUNTIES.....	\$ 29.64	25.77

ELEC0016-003 04/01/2023		

CRAWFORD, DAVIESS, DUBOIS, GIBSON, LAWRENCE, MARTIN, ORANGE, PERRY, PIKE, POSEY, SPENCER, VANDERBURGH, WARRICK

	Rates	Fringes
ELECTRICIAN.....	\$ 41.04	18.94

ELEC0016-006 08/31/2024		

CRAWFORD, DAVIESS, DUBOIS, GIBSON, LAWRENCE, MARTIN, ORANGE, PERRY, PIKE, POSEY, SPENCER, VANDERBURGH, WARRICK

	Rates	Fringes
ELECTRICIAN (Communication Technician Only).....	\$ 33.98	18.04

ELEC0071-006 01/02/2024		

DEARBORN, OHIO, and SWITZERLAND COUNTIES

	Rates	Fringes
Line Construction:		
Equipment Operator.....	\$ 39.11	4%+15.57
Groundman.....	\$ 25.90	4%+12.93
Lineman & Cable Splicers....	\$ 44.52	4%+16.65

ELEC0153-003 06/01/2023

ELKHART, KOSCIUSKO and MARSHALL COUNTIES

	Rates	Fringes
Communication Technician.....	\$ 26.50	18.33
ELECTRICIAN.....	\$ 38.00	26.47

Includes the installation, operation, inspection, modification, maintenance and repair of systems used for the transmission and reception of signals of any nature, for any purpose, including but not limited to , sound and voice transmission/transference systems, communication systems that transmit or receive information and /or control systems, television and video systems, micre-processor controlled fire alarm systems, and security systems and the performance of any task directly related to such installation or service. The scope of work shall exclude the installation of electrical power wiring and the installation of conduit raceways exceeding fifteen (15) feet in length.

ELEC0212-002 11/30/2023

DEARBORN, OHIO, and SWITZERLAND COUNTIES

	Rates	Fringes
ELECTRICIAN (Communication Technician Only).....	\$ 27.20	14.54

ELEC0212-009 06/07/2024

DEARBORN, OHIO, and SWITZERLAND COUNTIES

	Rates	Fringes
ELECTRICIAN.....	\$ 35.43	22.05

ELEC0305-003 12/01/2023

ADAMS, ALLEN, DE KALB, HUNTINGTON, LAGRANGE, NOBLE, STEUBEN,
WELLS, and WHITLEY COUNTIES

	Rates	Fringes
ELECTRICIAN.....	\$ 38.31	27.43%+10.66

ELEC0305-004 08/31/2023

ADAMS, ALLEN, DE KALB, HUNTINGTON, LAGRANGE, NOBLE, STEUBEN,
WELLS, and WHITLEY COUNTIES

	Rates	Fringes
ELECTRICIAN (Communication Technician Only).....	\$ 34.50	18.74

ELEC0369-005 05/29/2024		

CLARK, FLOYD, HARRISON, JACKSON, JEFFERSON, SCOTT, and WASHINGTON Counties

	Rates	Fringes
ELECTRICIAN.....	\$ 37.88	21.38

ELEC0481-003 03/31/2024		

BARTHOLOMEW, BOONE, DECATUR, HAMILTON, HANCOCK, HENDRICKS, JENNINGS, JOHNSON, MADISON, MARION, MONTGOMERY, MORGAN, PUTNAM, RIPLEY, RUSH AND SHELBY COUNTIES

	Rates	Fringes
ELECTRICIAN.....	\$ 42.15	26.88

ELEC0481-004 01/01/2023		

BARTHOLOMEW, BOONE, DECATUR, HAMILTON, HANCOCK, HENDRICKS, JENNINGS, JOHNSON, MADISON, MARION, MONTGOMERY, MORGAN, PUTNAM, RIPLEY, RUSH AND SHELBY COUNTIES

	Rates	Fringes
ELECTRICIAN (Communication Technician Only).....	\$ 35.76	18.96

ELEC0531-002 05/31/2023		

JASPER, PULASKI, and STARKE COUNTIES

	Rates	Fringes
ELECTRICIAN.....	\$ 43.50	30.64

ELEC0531-003 05/28/2018		

JASPER, PULASKI, and STARKE COUNTIES

	Rates	Fringes
ELECTRICIAN (Communication Technician Only).....	\$ 27.64	13.23

ELEC0538-005 06/01/2024		

FOUNTAIN, VERMILLION, and WARREN Counties

	Rates	Fringes
ELECTRICIAN.....	\$ 40.00	26.01

ELEC0538-009 09/01/2024		

FOUNTAIN, VERMILLION, and WARREN Counties

	Rates	Fringes
ELECTRICIAN (Communication Technician Only).....	\$ 38.88	19.02

ELEC0668-001 06/01/2023		

BENTON, CARROLL, CASS, FULTON, TIPPECANOE and WHITE COUNTIES

	Rates	Fringes
ELECTRICIAN (Communication Technician Only).....	\$ 33.02	16.10

ELEC0668-002 06/01/2024		

BENTON, CARROLL, CASS, FULTON, TIPPECANOE and WHITE COUNTIES

	Rates	Fringes
ELECTRICIAN.....	\$ 39.33	23.05

FOOTNOTE: a. PAID HOLIDAYS: New Years Day, Memorial Day, July 4th, Labor Day, Veterans Day Thanksgiving Day and Christmas Day		

ELEC0697-003 08/31/2024		

NEWTON COUNTY

	Rates	Fringes
ELECTRICIAN (Communication Technician Only).....	\$ 39.50	29.87

ELEC0697-006 06/01/2024		

NEWTON COUNTY

	Rates	Fringes
ELECTRICIAN.....	\$ 48.10	31.28

* ELEC0702-003 01/02/2025		

DUBOIS, GIBSON, PERRY, PIKE, POSEY, SPENCER AND VANDERBURGH COUNTIES

	Rates	Fringes
Line Construction:		
GROUNDMAN, Class A.....	\$ 33.96	30% + 8.85
GROUNDMAN-EQUIPMENT OPERATOR (All other equipment).....	\$ 43.19	30% + 8.85
HEAVY-EQUIPMENT OPERATOR (All crawler type equipment D-4 and larger)...	\$ 49.30	30% + 8.85
LINEMAN.....	\$ 60.15	30% + 8.85

ELEC0725-007 06/01/2022

BROWN, CLAY, GREENE, KNOX, MONROE, OWEN, PARKE, SULLIVAN AND VIGO COUNTIES

	Rates	Fringes
Communication Technician.....	\$ 30.00	18.07

Includes the installation, operation, inspection, maintenance, repair and service of radio, television, recording, voice sound and vision production and reproduction apparatus, equipment and appliances used for domestic, commercial, education, entertainment and private telephone systems.

ELEC0725-014 10/01/2024

BROWN, CLAY, GREENE, KNOX, MONROW, OWEN, PARKE, SULLIVAN AND VIGO COUNTIES

	Rates	Fringes
ELECTRICIAN.....	\$ 43.30	25.32

ELEC0855-002 06/01/2024

BLACKFORD, DELAWARE, FAYETTE, FRANKLIN, HENRY, JAY, RANDOLPH, UNION and WAYNE Counties

	Rates	Fringes
ELECTRICIAN (Communication Technician Only).....	\$ 36.94	17.52

ELEC0855-004 06/01/2024

BLACKFORD, DELAWARE, FAYETTE, FRANKLIN, HENRY, JAY, RANDOLPH, UNION and WAYNE Counties

	Rates	Fringes
ELECTRICIAN.....	\$ 38.53	21.42

ELEC0873-001 06/01/2021

CLINTON, GRANT, HOWARD, MIAMI, TIPTON, AND WABASH COUNTIES

	Rates	Fringes
ELECTRICIAN (Communication Technician Only).....	\$ 30.08	17.23

ELEC0873-002 03/01/2022

CLINTON, GRANT, HOWARD, MIAMI, TIPTON AND WABASH COUNTIES:

	Rates	Fringes
ELECTRICIAN.....	\$ 36.59	20.12

REMAINING COUNTIES

	Rates	Fringes
Line Construction:		
EQUIPMENT OPERATOR 1:		
Diggers, 5th wheel type		
trucks, crawler type, D-4		
and smaller, bucket trucks		
and live boom type line		
trucks.....	\$ 36.86	28%+7.64
EQUIPMENT OPERATOR 3		
(Backhoes over 1/2 yard		
bucket capacity, cranes		
rated at 15 ton or more		
capacity) 95% J.L. rate.....	\$ 45.53	28%+7.64
GROUNDMAN TRUCK DRIVER.....	\$ 27.57	29%+6.75
GROUNDMAN.....	\$ 25.04	29%+6.75
LINEMAN.....	\$ 48.35	28%+7.64

INCLUDING UNDERGROUND AND UTILITY CONSTRUCTION

ADAMS, ALLEN, BENTON, BLACKFORD, CARROLL, CASS, CLINTON,
 DEKALB, DELAWARE, FAYETTE, GRANT, HAMILTON, HANCOCK, HENRY,
 HOWARD, HUNTINGTON, JAY, JOHNSON, MADISON, MARION, MIAMI,
 RANDOLPH, RUSH, SHELBY, STEUBEN, TIPPECANOE, TIPTON, UNION,
 WABASH, WAYNE, WELLS, WHITE AND WHITLEY COUNTIES

	Rates	Fringes
Power equipment operators:		
GROUP 1.....	\$ 40.55	21.80
GROUP 2.....	\$ 38.83	21.80
GROUP 3.....	\$ 37.91	21.80
GROUP 4.....	\$ 36.41	21.80

POWER EQUIPMENT OPERATOR CLASSIFICATIONS

GROUP 1: Air compressors in manifold with throttle valve;
 Asphalt plant engineer; Auto grade or similar type machine;
 Auto patrol; Backhoe or farm-type tractor, 45 hp and over;
 Ballast regulator (RR); Bituminous mixer; Bituminous paver;
 Bituminous plant engineer; Bulldozer; Caisson drilling
 machine; Cherry picker, 15 ton or over; Chip spreader;
 Concrete mixer 21 cu. ft. or over; Core drilling machine;
 Crane or derrick with any attachment (including clamshell,
 dragline, shovel, backhoe, etc.); Dredge engineer; Dredge
 operator; Drilling machine on which the drill is an integral
 part; Earth mover, rubber-tired (paddle wheel, 616, 631,
 TS-24 or similar type); Earth mover, rubber-tired, tandem
 (\$0.50 per hour additional for each bowl); Elevating
 grader; Fork lift, 10 ton or over; P.C.C. formless paver
 post driver; Highlift shovel, 1 1/2 cu. yd. or over; Hoist,
 2 drums and over; Helicopter, crew; Hydraulic boom truck;
 keystone, skimmer scoop; Loader, self-propelled (belt,
 chain, wheel); Locomotive operator; Mechanic; Mucking
 machine; Panel board concrete plant, central mix type;
 Paver, Hetherington; Pile driver, skid or crawler; Road
 paving mixer; Rock breaking plant; Rock crushing plant,

portable; Roller (asphalt, waterbound macadam, bituminous macadam, brick surface); Roller with dozer blade; Root rake, tractor-mounted; Self-propelled widener; Stump remover, tractor-mounted; Surface heater and planer; Tandem push tractor (\$0.50 per hour additional); Tractor, boom; Winch or hoe head; Tractor, push; Tractor with scoop; Tractor-mounted spreader; Tree mover; Trench machine, over 24"; Tug boat operator; Well drilling machine; Winch truck with A-frame

GROUP 2: Air compressor with throttle valve or clever brooks-type combination; Backfiller; Backhoe on farm-type tractor, under 45 hp; Bull float; Cherry picker under 15 ton; Chip spreader, self-propelled; Concrete pump; Concrete mesh depressor, independently operated; Concrete spreader, power-driven; End loader under 1 1/2 cu. yd.; Excavating loader, portable; Finishing machine and bull float; Gunite machine; Head greaser; Mesh or steel placer; Multiple tamping machine (RR); P.C.C. concrete belt placer; Pull grader, power control; Refrigerating machine, freezing operation; Ross carrier; Sheepfoot roller (self-propelled); Tamper (multiple vibrating, asphalt, waterbound macadam, bituminous macadam, brick surface); Trench machine, 24" and under; Tube float; Welder

GROUP 3: Assistant plant engineer; Base paver (Jersey or similar type machine); Concrete finishing machine; Concrete mixer, less than 21 cu. ft.; Curb machine; Farm tractor, including farm tractor with all attachments except backhoe and including high lift end loaders of 1 cu. yd. capacity or less; Fire tender on boiler; Hoist, 1 drum; Operator, 5 pieces of minor equipment; Paving breaker; Power broom, self-propelled; Roller, earth and sub-base material; Slurry seal machine; Spike machine (RR); Tamper (multiple vibrating, earth and sub-base material); Throttle valve and fire tender combination on horizontal or upright boiler; Tractaire with drill; Tractor, 50 h.p. or over; Well point system; Widener, APSCO or similar type

GROUP 4: Air compressor; Assistant to engineer, oiler; Automatic dry batch plant; Bituminous distributor; Bituminous patching tamper; Belt spreader; Broom and belt machine; Chair cart, self-propelled; Coleman-type screen; Conveyor, portable; Digger post hole, power-driven; Fork lift, under 10 ton; Form grader; Form tamper, motor-driven; Generator; Hetherington driver; Hydra seeder; Operator, 1 through 4 pieces of minor equipment; Outboard or inboard motor boat; Power curing spraying machine; Power saw, concrete, power-driven; Pug mill; Pull broom, power-type; Seaman tiller; Straw blower or brush mulcher; Striping machine paint, motor-driven; Sub grader; Tractaire, tractor, below 50 h.p.; Truck crane oiler, driver; Spreader; Water pump; Welding machine, 2 of 300 amps or over

ENGI0150-009 04/01/2024

HEAVY, HIGHWAY AND RAILROAD CONSTRUCTION

ELKHART, FULTON, JASPER, KOSCIUSKO, LAGRANGE, MARSHALL, NEWTON,
NOBLE, PULASKI, and STARKE COUNTIES

Rates

Fringes

POWER EQUIPMENT OPERATOR

GROUP 1.....	\$ 36.40	35.15
GROUP 2.....	\$ 34.80	35.15
GROUP 3.....	\$ 33.50	35.15
GROUP 4.....	\$ 32.10	35.15
GROUP 5.....	\$ 24.30	30.85

POWER EQUIPMENT OPERATOR CLASSIFICATIONS

GROUP 1: Air compressors in manifold with throttle valve; Asphalt plant engineer; Auto grade or similar type machine; Auto patrol; Automatic Sub-Grade; Backhoe or farm type tractor, 45 hp and over; Ballast regulator (RR); Barrier Wall Machine; Batch Plants (Concrete & Asphalt); Bituminous mixer; Bituminous paver; Bituminous plant engineer; Boring Machine; Bulldozer; Caisson drilling machine; Cherry picker, 15 ton or over; Chip spreader; Concrete mixer, 21 cu. ft. or over; Concrete Belt Placer; Concrete Paver; Concrete Pump (Truck Mounted); Concrete Saw (track mounted); Concrete Spreader (power driven); Core drilling machine; Crane or derrick with any attachment (including clamshell, dragline, shovel, backhoe, etc.); Curb Machine; Gutter Machine; Dredge engineer; Dredge operator; Drilling machine on which the drill is an integral part; Earthmover, rubber-tired (paddle wheel, 616, 631, TS-24 or similar type); Earthmover, rubber-tired, tandem (.50 per hr. additional for each bowl); Elevating Grader; Forklift (10 ton or over); P.C.C. Formless Paver; Gradall; Gravel Processing Plant (portable); Operator of Guard Rail Post Driver; Highlift Shovel 1-1/2 cu.yd. or over) Frame; Hoist (2 drum & over); Helicopter crew; Hydraulic boom truck; Hydraulic Excavator; Loaded-Self propelled (belt chain wheel); Laser Screed; Locomotive operator; Mechanic; Mucking machine; P.C.C. Concrete Belt Placer; Panel board concrete plant (central mix type); Paver (Hetherington); Pavement Breaker; Pile driver, skid or crawler; Road paving mixer; Rock breaking plant; Rock crushing plant (portable); Roller (asphalt, waterbound macadam, bituminous macadam, brick surface); Roller with dozer blade; Road Widener; Root rake (tractor-mounted); Roto Mill Grinder; Self-propelled widener; Stump remover; Surface heater and planer; Tandem push tractor (\$0.50 per hour additional); Tractor, boom; Winch or hoe head; Tractor (push); Tractor with scoop; Tractor-mounted spreader; Tree mover; Trench machine, over 24"; Tug boat operator; Well drilling machine; Widener (Apsco or similar type); Winch truck with A-frame

GROUP 2: Air compressor with throttle valve or Clever Brooks type combination; Backfiller; Farm type tractor (under 45 H.P.); Cherry picker under 15 ton; Chip spreader (self-propelled); Concrete pump (trailer type); Concrete mesh depressor, independently operated; End loader under 1 1/2 cu. yd.; Excavating loader (portable); Finishing machine and bull float; Guniting machine; Hydraulic Power unit; Head greaser; Mesh or steel placer; Multiple tamping backhoe on machine (RR); Bull float (bidwell Machine); Refrigerating machine-operation; Ross Carrier; Sheepfoot roller (self-propelled); Tamper-Multiple Vibrating (Asphalt, Waterbound, Macadam, Bituminous Macadam, Brick Surface); Trench machine (24" and under); Tube float; Water Pull/Wagon; Welder

GROUP 3: Plant engineer; Base paver (Jersey or similar type machine); Concrete finishing machine; Concrete mixer, less

than 21 cu. ft.; Curb machine; Farm tractor, including farm tractor with all attachments except backhoe and including high lift end loaders of 1 cu. yd. capacity or less; Fireman, on boiler; Hoist, 1 drum; Operator, 3-5 pieces of minor equipment; Paving breaker; Power broom, self-propelled; Roller, earth and sub-base material; Power Saw-Concrete (Power Driven); Slurry seal machine; Spike machine (RR); Sub-surface Material Distributor; Tamper (multiple vibrating, earth and sub-base material); Throttle valve; Throttle Valve and fireman combination on horizontal or upright boiler; Tractaire with drill; Well Point

GROUP 4: Air compressor; Assistant to engineer, oiler; Bituminous patching tamper; Belt spreader; Broom and belt machine; Chair cart, self-propelled; Coleman-type screen; Conveyor, portable; Deck-hand Digger post hole, power-driven; Forklift, under 10 ton; Form grader; Form tamper, motor-driven; Generator; Hetherington driver; Hydra seeder; Mechanic heater; Operator, 2 pieces of minor equipment; Outboard or inboard motor boat; Power curing spraying machine; Pug mill; Pull broom, power type; Seaman tiller; Skid steer loader over 3/4 cu. yd.; Straw blower or brush mulcher; Striping machine paint, motor-driven; Sub-grader; Tractaire; Tractor, below 50 h.p.; Truck crane oiler; Spreader; Water pump

GROUP 5: Skid steer loader under 3/4 cu. yds

 ENGI0150-039 06/01/2024

UNDERGROUND & UTILITY CONSTRUCTION:

JASPER, NEWTON, PULASKI AND STARKE COUNTIES:

	Rates	Fringes
POWER EQUIPMENT OPERATOR		
GROUP 1.....	\$ 46.55	44.48
GROUP 2.....	\$ 45.75	44.48
GROUP 3.....	\$ 41.45	44.48
GROUP 4.....	\$ 39.25	44.48
GROUP 5.....	\$ 33.80	44.48

POWER EQUIPMENT OPERATOR CLASSIFICATIONS

GROUP 1: Asphalt plants (construction), Asphalt plant (permanent), Auto Patrol (Maintainer), Automatic Dry Batch Plant, Automated Concrete Placer, Automated Sub-Grader, Automated Slip Form Paver, Automated Finish Machine, Combination Backhoe Front, End Loader Machine (1/2 cu. yd.), Backhoe bucket or over or with attachments), Combination backhoe 1 cu yd, Backhoe bucket or over or with attachments, Ballast Regulator (RR), Belt Loader (stationary), Boring Machine (road), Bulldozer, Concrete Mixer(27 cu. ft. or over), Concrete Pump (truck mounted), Concrete Breaker (truck mounted and self-propelled), Core Drilling Machine, Cranes and Backhoes (all attachments), Cranes, Hammerhead, Creter Crane, Crushers (concrete, rock, recycling, etc.), Derricks , Derricks (traveling), Dredge Operator, Formless Curb and Gutter Machine (36 inches and over), Formless Curb and Gutter Machine under 36 inches, Gradall and Machines (of a like nature), Guardrail Post Driver (truck mounted), Lead Greaser, Helicopter, Highlift Shovel (3 yd. and over), Hoist (1 drum), Hoist (2, and 3

drums), Hydraulic Power Units (grouting, piledriving and extracting) Hydro or water blaster (self-propelled), Locomotive Operators, Mechanic, Welder, Mucking Machine, Panelboard Concrete Plant (central mix type), Paver (Hetherington), Pile Driver (Skid or Crawler), Road Paving Mixer, Rock Drill Crawler or Skid Rig, Rock Drill (truck Mounted), Ross Carrier, Roto Mill Grinder (36" and over), Roto mill grinder (less than 36"), Throttle Valve and Compressor or Clever Brooks Type Combination, Throttle Valve and Fireman Combination or Horizontal or Upright Boiler, Tournapull or similar type equipment, Tractor (boom), Tractor Drawn Belt Loader with attached Pusher (requires two engineers), Trench Machine, Tug Boat Operator, Wheel Excavator, Winch Tractor with "a" frame, Scoops, Turnapull or similar types machine used in Tandem (add \$1.00 to class 1 hourly rate for each machine attached there to).

GROUP 2: Combination Backhoe Front End Loader Machine with less than 1/2 cu. yd., Backhoe Bucket or with attachments, Bituminous Mixer, Bituminous Paver, Bridge Deck Finisher, Concrete Mixer (less than 27 cu. ft.), Compressor and throttle valve, Compressor (common receiver 3), Greaser, Highlift Shovels (under 3 cu. yds.), Jersey Spreader or Base Paver, Pavement Bump Grinder (self-propelled), Roller (Asphalt, waterbound, Macadam, Bituminous Macadam, Brick Surface, Sheepfoot Roller (self-propelled with blade), Surface Heater and Planer, Tamper (mutiple vibrating, asphalt waterbound macadam, bituminous macadam, brick surface), Tractor (push), Tractor with scoop, Widener, Apsco or similar type.

GROUP 3: Back Filler, Bituminous Distributor, Broom and Belt Machine, Bull Float, Compressor (common receiver 2), Concrete cutter wheel type (rockwell), Concrete Finishing Machine, Concrete Spreader (power driven), Digger, Post Hole (power driven), Finishing Machine and Bull Float, Forklift, Form Grader, Form Tamper (motor driven), Hydraulic (boom truck) when used for hauling materials, Laser screed, Mutiple Tamping Machine, Paving Breaker, Roller (earth and subbase material), Roller sheepfoot (self-propelled), Sub-grader, Tamper, Mutipile Vibrating (earth and subbase material), Tractaire with Drill, Tractor (with all drawn attachments except backhoe and including Highlift, Endloader of 1 cu. yd. capacity and less.

GROUP 4: Air Compressors, Conveyor (all), Fireman on Boiler, Generator, Grout Machine, Power curing Spraying Machine (self-propelled), Broom (self-propelled), Seaman Tiller, Skid steer loaders, Spike Machine (RR), Stripping Machine (paint, self-propelled), Throttle Valve, Welding Machine, Well Points System.

GROUP 5: Deck Hand, Hetherington Driver, Mechanical Heater (1 to 5), Outboard or Inboard Motor Boat, Oiler, Power Saw (Concrete Power Driven), Water Pump, Grasscutter.

ENGI0181-014 04/01/2024

HEAVY AND HIGHWAY CONSTRUCTION:

BARTHOLOMEW, BROWN, CLARK, CRAWFORD, DEARBORN, DECATUR, DUBOIS, FLOYD, FRANKLIN, GIBSON, HARRISON, JACKSON, JEFFERSON, JENNINGS, LAWRENCE, MARTIN, OHIO, ORANGE, PERRY, PIKE, POSEY,

RIPLEY, SCOTT, SPENCER, SWITZERLAND, VANDERBURGH, WARRICK, and WASHINGTON COUNTIES

	Rates	Fringes
Power equipment operators:		
GROUP A.....	\$ 44.70	19.10
GROUP B.....	\$ 42.05	19.10
GROUP C.....	\$ 39.92	19.10

POWER EQUIPMENT OPERATOR CLASSIFICATIONS

GROUP A: Air compressor in manifold with throttle valve; Asphalt plant engineer; Auto grade or similar type machine; Bituminous mixer; Bituminous paver; Bituminous plant engineer; Bulldozer; Caisson drilling machine; Cherry picker, all; Ballast regulator (RR); Chip spreader, self-propelled; Cold grinder or similar type equipment; Concrete mixer, 21 cu. ft. or over; Concrete pump, truck-mounted; Core drilling machine; Crane or derrick with any attachment (including clamshell, dragline, shovel, backhoe, etc.); Dredge operator; Drilling machine on which the drill is an integral part; Earth mover, rubber-tired, tandem \$0.50 per hour additional; Elevating grader; Endloader, Hi- lift shovel; P.C.C. formless paver; Gradall; Gravel processing plant, portable; Guardrail post driver operator; Head greaser; Hi-lift shovel, endloader; Hoist (2 drums and over); Helicopter crew; Hydraulic boom truck, Keystone, Skimmer Scoop; Loader, self-propelled (belt, chain wheel); Locomotive operator; Mechanic; Mucking machine; Multi-bank drill operator; Panel board concrete plant, central mix type; Paver, Hetherington; Pile driver, skid or crawler; Road paving mixer; Rock breaking plant; Rock crushing plant, portable; Roller (asphalt, waterbound, macadam, bituminous macadam, brick surface); Roller, with dozer blade; Root rake, tractor-mounted; Stump remover, tractor-mounted; Surface heater and planer; Tandem push tractor, \$0.50 per hour additional; Tractor, boom winch or hoe head; Tractor, push; Tractor with scoop; Tractor-mounted spreader; Tree mover; Trench machine, over 24"; Tug boat operator; Welder; Well drilling machine; Self-propelled widener.

GROUP B: Air compressor with throttle valve or clever brooks-type combination; Backfiller, base paver, Jersey or similar type machine; Bull float; Concrete finishing machine; Concrete mesh depressor, independently operated; Concrete spreader, power- driven; Dredge engineer; Excavator loader, portable; Fire tender on boiler; Forklift, regardless of ton; Hoists, 1 drum; Mesh or steel placer; Minor equipment operator, 5 pieces; Multiple tamping machine (RR); P.C.C. concrete placer; Paving breaker; Power broom, self-propelled; Pull grader, power-controlled; Refrigerating machine, freezing operation; Roller, earth and sub- base material; Ross carrier (Straddle buggy); Sheepfoot roller, self-propelled without blade; Tamper, multiple vibrating (asphalt, waterbound macadam, bituminous macadam, brick surface); Tamper, multiple vibrating (earth and sub-base material); Trench machine, 24" and under; Tube float; Well point system; Widener, Apsco or similar type; Winch truck with A-frame.

GROUP C: Air compressor, oiler; Automatic dry batch plant;

Bituminous distributor; Bituminous patching tamper; Belt spreader; Broom and belt machine; Brush burner; Chair cart, self-propelled; Coleman-type screen; Cold grinder oiler; Concrete mixer, less than 21 cu. ft.; Conveyor, portable; Curb machine; Deckhand; Digger (post hole, power-driven); Farm tractor, including farm tractor with all attachments (except backhoe, Hi-lift endloaders); Form grader; Form tamper, motor-driven; Generator; Guniting machine; Hetherington driver; Hydra seeder; Mechanical heater; Minor equipment operator, 1 through 4 pieces; Curing spraying machine; Power saw, concrete (power-driven); Pug mill pull broom, power type; Seaman tiller; Slurry seal machine; Spike machine; Straw blower or brush mulcher; Stripping machine (paint, motor-driven); Sub grader; Throttle valve; Tractaire with drill; Truck crane and multi-drill oiler, driver; Spreader; Water pump.

 ENGI0181-015 04/01/2022

SEWER WATERLINE & UTILITY CONSTRUCTION:

BARTHOLOMEW, BROWN, CLARK, CRAWFORD, DEARBORN, DECATUR, DUBOIS, FLOYD, FRANKLIN, GIBSON, HARRISON, JACKSON, JEFFERSON, JENNINGS, LAWRENCE, MARTIN, OHIO, ORANGE, PERRY, PIKE, POSEY, RIPLEY, SCOTT, SPENCER, SWITZERLAND, VANDERBURGH, WARRICK, and WASHINGTON COUNTIES

	Rates	Fringes
Power equipment operators:		
GROUP A.....	\$ 39.50	19.28
GROUP B.....	\$ 36.85	19.28

SEWER WATERLINE & UTILITY CONSTRUCTION

GROUP A: A-frame winch truck; Air compressor 900 cu. ft. and over; Air tugger; Autograde (CMI); Auto patrol; Backhoe; Ballast regulator (RR); Batch plant (electrical control concrete); Bending machine (pipe); Bituminous plant (engineer); Bituminous plant; Bituminous mixer travel plant; Bituminous paver; Bituminous roller; Buck hoist; Bulldozer; Cableway; Chicago boom; Clamshell; Concrete mixer, 21 cu. ft. or over; Concrete paver, concrete pump, crete; Crane; Craneman; Crusher plant; Derrick; Derrick boat; Dinky; Dope pots (pipeline); Dragline; Dredge operator; Dredge engineer; Drill operator; Elevator grader; Elevator; Ford hoe, or similar type equipment; Forklift; Formless paver; Gantry crane; Gradall; Grademan; Hopto; Hough loader or similar type; Hydro crane; Motor crane; Mucking machine; Multiple tamping machine (RR); Overhead crane; Pile driver; Pulls; Push dozer; Push boats; Roller (sheep foot); Ross Carrier; Scoop; Shovel; Side boom; Swing crane; Trench machine; Welder (heavy duty; Truck-mounted concrete pump; Truck-mounted drill; Well point; Whirleys.

GROUP B: Air compressor, up to 900 cu. ft.; Brakeman; Bull float; Concrete mixer, over 10S and under 21S; Concrete spreader or puddler; Deck engine; Electric vibrator compactor (earth or rock); Finishing machine; Fireman; Greaser, on grease facilities servicing heavy equipment; Material pump; Motor boats; Portable loader; Post hole digger; Power broom; Rock roller; Roller, wobble wheel (earth and rock); Spike machine (RR); Seaman tiller;

Spreader rock; Sub grader; Tamping machine; Welding machine; Widener, Apsco or similar type: Bituminous distributor; Cement gun; Concrete saw; Conveyor; Deckhand oiler; Earth roller; Form grader; Generator; Guard rail driver; Heater; JLG lifts; Oiler; Paving joint machine; Power traffic signal; Scissor lift; Steam Jenny; Truck crane oiler; Vibrator; Water pump.

 ENGI0841-011 04/01/2024

HEAVY, HIGHWAY AND UTILITY CONSTRUCTION

BOONE, CLAY, DAVIESS, FOUNTAIN, GREENE, HENDRICKS, KNOX, MONROE, MONTGOMERY, MORGAN OWEN, PARKE, PUTNAM, SULLIVAN, VERMILLIAN, VIGO, and WARREN COUNTIES

	Rates	Fringes
Power equipment operators:		
GROUP 1.....	\$ 38.80	27.15+a
GROUP 2.....	\$ 32.55	27.15+a

POWER EQUIPMENT OPERATOR CLASSIFICATIONS

GROUP 1: Air Compressor Over 600 CU FT, Air Compressors (2), Compressors hooked in Manifold, Asphalt Plant Engineer, Auto Grade and/or C.M.I. or similar type Machine, Auto Patrol, Motor Patrol, Power Blade, Aspco Paver, Asphalt Planer, Asphalt Rollers, Asphalt Paver Operator, Concrete or Asphalt Milling Machine, Self Propelled Widener, Backhoe and/or Pavement Breaker Attachment, Self Propelled Pavement Breaker, Ballast Regulator (R.R), Bituminous Mixer, Bituminous Paver, Bituminous Plant Engineer, Bulk Cement Plant Engineer, Bulldozer, One Drum Hoist with Tower or Boom, Cableways, Tower Machines, Back Filler, Boom Tractor, Boom or Winch Truck, Winch or Hydraulic Boom Truck, Boring Machine, Bolier Operator, Brush Mulcher, Bull Float, Finishing Machine, Power Cranes, Overhead Cranes, Truck cranes, Piledriver, Skid or Crawler, Guard Rail Post Driver, Tower Cranes, Hydro Crane, Cherry Picker, Draglines, Derricks, Shovels, Clam, Gradalls, Two Drum Machine, Concrete or Asphalt Curb Machine, Self Propelled, Concrete Mixers with Skid, Tournamixer, Concrete Pump (Truck or Skid Mounted), Concrete Plant Engineer, Soil Cement Machine, Formless Paver, Concrete Spreader, Span Saw (and similar types), Chip Spreader, Mesh Placer, Dredging Equipment or Dredge Engineer or Dredge Operator, Tug Boat Operator, Marine Scoops, Ditching Machine with Dual Attachment, Standard or Dinkey Locomotives, Drilling Machine, including Well Testing, Caissons, Shaft or any similar type Drilling Machine (Well Point Systems), 4 Point Life System (Power Lift or similar type), Mud Cat, Mucking Machine, Sull-Air, Mechanics, Welder, Head Equipment Greaser, Tournapull, Tractor Operating Scoops, Push Tractors, Large Rollers on Earth, Loaders (Track or Rubber Mounted), or similar type Machine, Lull, Tournadozer, Scoopmobiles, Elevating Machines, Power Broom (Self Propelled), Power Sub Grader, Hydra Ax, Farm Tractor with Attachments, Soil Stabilizer (Seaman Tiller, Bo mag, Rago Gator and similar types of equipment), Tree Mover, Stump Remover, Root Rake, Hydra Seeder, Straw Blower, Refrigerating Machine, Freezing Operator, Chair Cart-Self Propelled, Helicopter Crew (3), Ross Carrier or Straddle

Buggy or similar Machine, Rock Crusher Plant, Gravel Processing Machine, Pipe Cleaning Machine, Pipe Wrapping Machine, Pipe Bending Machine, Pug Mill, Concrete Bump Grinder Machine, Power Curing Spray Machine, Forklift (except when used for landscaping), Snooper Truck Operator.

GROUP 2: Air Compressor 600 cu. ft. and under, Air Tugger, Air Valves, Assistant Concrete Plant Engineer, Assistant Asphalt Plant Engineer, Asphalt Plant Fireman, Bulk Cement Plant Equipment Greaser, Concrete Mixers without Skips, Curbing Machine, Concrete Saw (Self Propelled), Conveyors, Cement Blimps, Ditching Machine under 6", Distributor Operator On trucks, Deck Hands, Elevators when used for hoisting material, Engine Tenders, Fork Lift (when used for landscaping), Farm Tractor, Fireman, Fireman on Paint or Dope Pots, Form Tamper, Form Grader, Flex Plane, Generators (two to four), or Welding Machines or Water Pumps, within 400 feet, Gunite Machine, Machine Mounted Post Hole Digger, Mude Jack, One Drum Machines without Tower or Boom, One Water Pump, One Welding Machine, Outboard or Inboard Motor Boat, Pull Broom (Power Type, Siphons and Pulsometer, Switchman, Striping and or Painting Machine (motor driven), Slurry Seal Machine, Track Jack, Temporary Heat, Throttle Valve, Tube Float, Tractaire, Wagon Drill, Multiple Tamping Machine (R.R.), Spike Machine (R.R.), Mechanical Heaters, Brush Burner, Vacuum Truck (Super Sucker and similar types).

FOOTNOTES:

A. Employees operating booms from 149Ft. to 199 Ft. including jib, shall receive an additional seventy-five Cents (.75) per hour above the rate. Employees operating booms over 199 Ft. including jib, shall receive an additional one dollar and twenty- five cents (\$1.25) per hour above the regular rate.

B. Employees operating scoops, pulls, or tractors hooked in tandem shall receive an additional one dollar (\$1.00) per hour above the regular rate.

C. Employees operating scoops, pulls, or tractors pulling any other hauling unit in tandem shall receive an additional one dollar (\$1.00) per hour above the regular rate.

D. Underground work - Employees working in tunnels, shafts, etc. shall be paid a thirty percent (30%) premium above the wage rate.

IRON0022-001 06/01/2024

BARTHOLOMEW, BENTON, BOONE, BROWN, CARROLL, CASS, CLAY, CLINTON, DAVIESS (REMAINDER OF COUNTY), DECATUR (W 3/4), DELAWARE (REMAINDER OF COUNTY), FAYETTE (W 1/3), FOUNTAIN, FRANKLIN (NW TIP), FULTON (REMAINDER OF COUNTY), GRANT (REMAINDER OF COUNTY), GREENE, HAMILTON, HANCOCK, HENDRICKS, HENRY, HOWARD, JACKSON, JASPER (SOUTHEASTERN 1/2), JENNINGS (NORTHWEST 2/3), JOHNSON, KNOX (REMAINDER OF COUNTY), LAWRENCE, MADISON, MARION, MARTIN (NW 2/3), MIAMI (REMAINDER OF COUNTY), MONROE, MONTGOMERY, MORGAN, NEWTON (SOUTHERN 1/2), OWEN, PARKE, PULASKI (REMAINDER OF COUNTY), PUTNAM, RANDOLPH (SW TIP), RUSH (REMAINDER OF COUNTY), SHELBY, SULLIVAN, TIPPECANOE, TIPTON, VERMILLION, VIGO, WAYNE, WARREN AND WHITE COUNTIES:

	Rates	Fringes
IRONWORKER.....	\$ 36.70	26.09

The following holidays shall be observed: New Year's Day, Memorial Day, Independence Day, Labor Day, Thanksgiving Day and the day after Thanksgiving and Christmas Day. Any holiday which occurs on a Sunday shall be observed the following Monday, unless the legal observance of these holidays is changed by law.

IRON0044-010 06/01/2024

DEARBORN, DECATUR (REMAINDER OF COUNTY), FAYETTE (REMAINDER OF COUNTY), FRANKLIN (REMAINDER OF COUNTY), JEFFERSON (REMAINDER OF COUNTY), JENNINGS (REMAINDER OF COUNTY), OHIO, RIPLEY, RUSH (SOUTHEASTERN TIP), SWITZERLAND, AND UNION (SOUTHERN 1/3)

	Rates	Fringes
Ironworkers:		
FENCE ERECTORS.....	\$ 30.75	22.30
ORNAMENTAL.....	\$ 35.39	24.80
STRUCTURAL, MACHINERY MOVERS, RIGGERS.....	\$ 35.39	24.80

IRON0070-002 06/01/2024

CLARK, CRAWFORD, FLOYD, HARRISON, JACKSON (SOUTHERN 3/4); JEFFERSON (EXCLUDING NORTHEASTERN TIP); JENNINGS (SOUTHERN 3/4), LAWRENCE (SOUTHERN 2/3), MARTIN (SOUTHEASTERN 2/3), ORANGE, PERRY (EASTERN 3/4); SCOTT AND WASHINGTON COUNTIES:

	Rates	Fringes
IRONWORKER.....	\$ 34.59	25.00

IRON0070-016 06/01/2024

DEARBORN, DECATUR (REMAINDER OF COUNTY), FAYETTE (SE CORNER), FRANKLIN (S 3/4), OHIO, RIPLEY (REM. OF COUNTY), SWITZERLAND (REMAINDER OF COUNTY) and JENNINGS (NE TIP) COUNTIES

	Rates	Fringes
IRONWORKER (Reinforcing).....	\$ 34.59	25.00

IRON0103-001 04/01/2024

DAVISS (S 1/2), DUBOIS, GIBSON, KNOX (S 1/2), MARTIN (SW 1/3), PERRY (W 1/4), PIKE, POSEY, SPENCER, VANDERBURGH, AND WARRICK

	Rates	Fringes
IRONWORKER.....	\$ 35.34	25.75

IRON0147-004 06/01/2024

ADAMS, ALLEN, BLACKFORD, DEKALB, DELAWARE (NORTHEAST THIRD OF COUNTY), FULTON (EASTERN PART), GRANT (EXCLUDING SOUTHWEST PORTION), HUNTINGTON, JAY, MIAMI (NORTHEAST HALF), NOBLE (EXCLUDING NORTHEAST TIP), STEUBEN, WABASH, WELLS, and WHITLEY COUNTIES

	Rates	Fringes
IRONWORKER.....	\$ 34.20	26.39

IRON0290-004 06/01/2024		

FAYETTE (NE 1/4), RANDOLPH (S. PART OF COUNTY EXCLUDING WINCHESTER BUT INCLUDING UNION CITY) UNION (NORTHERN 2/3) AND WAYNE (REMAINDER OF COUNTY) COUNTIES

	Rates	Fringes
Ironworkers:.....	\$ 35.39	24.35

IRON0292-005 06/01/2024		

ELKHART, FULTON (North 2/3), KOSCIUSKO (Remainder of County), LAGRANGE (West 1/3), MARSHALL, MIAMI (Northwestern Tip), NOBLE (Northwestern Tip), PULASKI (Northeast Half), and STARKE COUNTIES

	Rates	Fringes
IRONWORKER.....	\$ 37.83	24.75

IRON0395-002 06/01/2024		

JASPER (NORTHERN 1/2), NEWTON (NORTHERN 1/2), PULASKI (NORTHWESTERN TIP) COUNTIES

	Rates	Fringes
IRONWORKER		
IRONWORKERS.....	\$ 46.33	39.67
SHEETER.....	\$ 46.58	39.67

LABO0041-003 04/01/2024		

HEAVY & HIGHWAY CONSTRUCTION

NEWTON COUNTY

	Rates	Fringes
LABORERS		
Group 1.....	\$ 32.95	26.50
Group 2.....	\$ 33.25	26.50
Group 3.....	\$ 33.95	26.50

LABORERS CLASSIFICATIONS (HEAVY AND HIGHWAY)

GROUP 1: Construction Laborer, Carpenter Tender, Fence Erector, Grade Checker, Guard Rail Erector, Continuous Steel Rod or Mat Installer, Wire Mesh Layer, Joint Man (Mortar, Mastic, and all other types), Lighting Installer

(Permanent or Temporary), Lineman for Automatic Grade Maker on Paving Machines, Mortar Man, Multi-Plant Erector, Rip-rap Installer (all Products and Materials), Road Marking and Delineation Laborer, Setting and Placing of all Precast Concrete Products, Sign Installation including supporting structure, Spraying of all Epoxy, Curing Compound, or Like Material, Flagperson, Air Tool, Power Tool Operator, Asphalt Raker Man, Batch Truck Dumper, Bridge Hand Rail Erector, Handler (bulk or bag cement), Chain Saw Man, Concrete Puddler, Concrete Rubber, Concrete Saw Operator, Core Drill Operator, Eye Level, Hand Blade Operator Hydro Seeder Man, Motor Driven Georgia Buggy Operator, Power Driven Compactor or Taper Operator, Power Saw Operator, Pumpcrete Assembly Man, Sreed Man or Screw Man on Asphalt Paver, Regar Installer, Sandblaster Man, Sealer Applicator for Asphalt (toxic), Setting and Placing pre-stressed on Pre-cast Concrete Structural Members, Side Rail Setters (for Sidewalk, Side Ditches, Radii, and Pavement), Spreader Box Tender (manua or power driven), Straw Blower Man, Subsureface Drain and Culvert Pipe Layer, Concrete Conveyor, Horizontal Boring and Jackman and Sheetman, Pipe Greade Man, Winch and Windless Operator Conduit Installer, Sod Layer

GROUP 2: Cutting Torch Burner, Laser Beam Aligner, Manhole Erector, Sewer Pipe Layer, Water Line Installer, Temporary or Permanent Welders (electric or Oxy Acetylene)

GROUP 3: Air Track and Wagon Drillman, Dynamite and Powder Man, Concrete Barrier Rail Form Setter, Concrete Saw Joint Control Cutting

 LAB00041-005 04/01/2024

UTILITY CONSTRUCTION

JASPER & NEWTON COUNTIES

	Rates	Fringes
Laborers:		
GROUP 1.....	\$ 32.95	26.50
GROUP 2.....	\$ 33.25	26.50
GROUP 3.....	\$ 33.95	26.50

LABORERS CLASSIFICATIONS (UTILITY CONSTRUCTION)

GROUP 1: Construction laborer; Fence erector; Flagger; Grade checker; Guard rail erector; Wire mesh layer; Joint man (mortar, mastic and all other types); Lighting installer (permanent or temporary); Lineman for automatic grade maker on paving machines; Mortar man; Multi-plate erector; Rip-rap installer (all products and materials); Road marking and delineation laborer; Setting and placing of all precast concrete products; Sign installation including supporting structure; Spraying of all epoxy, curing compound, or like material; sod layer; Air tool, power tool, and power equipment operator; Asphalt lute man; Asphalt raker man; Batch truck dumper; Bridge handrail erector; Handler (bulk or bag cement); Chain saw man; concrete puddler; concrete rubber; Concrete saw operator; Core drill operator, eye level; Hand blade operator; Hydro seeder man; Motor-driven Georgia buggy operator; Power-driven compactor or tamper operator; Power saw

operator; Pumpcrete assembly man; Screed man or screw man on asphalt paver; Rebar installer; Sandblaster man; Sealer applicator for asphalt (toxic); Setting and placing prestressed or precast concrete structural members; Side rail setter (for sidewalks, side ditches, radii, and pavements); Spreader box tender (manual or power-driven); Straw blower man; Subsurface drain and culvert pipe layer; Transverse and longitudinal hand bull float man; Concrete conveyor assembly man; Horizontal boring and jacking man; Jackman and sheetman; Pipe grade man; Winch and windlass operator

GROUP 2: Cutting torch burner; Laser beam aligner; Manhole erector; Sewer pipe layer; Water line installer, temporary or permanent; Welder (electric or oxy-acetylene) in connection with waterline and sewer work, Hod Carrier (tending bricklayers); Tying and associated grouting of utility lines

GROUP 3: Air track and wagon drillman; Concrete barrier rail form setter; Dynamite and powder man; General leadman; Concrete Saw Joint Control cutting

LAB00041-006 04/01/2024

HEAVY & HIGHWAY CONSTRUCTION

JASPER & STARKE COUNTIES

	Rates	Fringes
LABORERS		
Group 1.....	\$ 30.18	26.50
Group 2.....	\$ 33.25	26.50
Group 3.....	\$ 33.95	26.50

LABORERS CLASSIFICATIONS (HEAVY AND HIGHWAY)

GROUP 1: Construction Laborer, Carpenter Tender, Fence Erector, Grade Checker, Guard Rail Erector, Continuous Steel Rod or Mat Installer, Wire Mesh Layer, Joint Man (Mortar, Mastic, and all other types), Lighting Installer (Permanent or Temporary), Lineman for Automatic Grade Maker on Paving Machines, Mortar Man, Multi-Plant Erector, Rip-rap Installer (all Products and Materials), Road Marking and Delineation Laborer, Setting and Placing of all Precast Concrete Products, Sing Installation including supporting structure, Spraying of all Epoxy, Curing Compound, or Like Material, Flagperson, Air Tool, Power Tool Operator, Asphalt Raker Man, Batch Truck Dumper, Bridge Hand Rail Erector, Handler (bulk or bag cement), Chain Saw Man, Concrete Puddler, Concrete Rubber, Concrete Saw Operator, Core Drill Operator, Eye Level, Hand Blade Operator Hydro Seeder Man, Motor Driven Georgia Buggy Operator, Power Driven Compactor or Taper Operator, Power Saw Operator, Pump Crete Assembly Man, Sreed Man or Screw Man on Asphalt Paver, Regar Installer, Sandblaster Man, Sealer Applicator for Asphalt (toxic), Setting and Placing pre-stressed on Pre-cast Concrete Structural Members, Side Rail Setters (for Sidewalk, Side Ditches, Radii, and Pavement), Spreader Box Tender (manua or power driven), Straw Blower Man, Subsureface Drain and Culvert Pipe Layer, Concrete Conveyor, Horizontal Boring and Jackman and Sheetman, Pipe Greade Man, Winch and Windless Operator

Conduit Installer, Sod Layer

GROUP 2: Cutting Torch Burner, Laser Beam Aligner, Manhole Erector, Sewer Pipe Layer, Water Line Installer, Temporary or Permanent Welders (electric or Oxy Acetylene)

GROUP 3: Air Track and Wagon Drillman, Dynamite and Powder Man, Concrete Barrier Rail Form Setter, Concrete Saw Joint Control Cutting

LAB00081-003 04/01/2024

UTILITY CONSTRUCTION

STARKE COUNTY

	Rates	Fringes
Laborers:		
GROUP 1.....	\$ 30.18	26.50
GROUP 2.....	\$ 33.25	26.50
GROUP 3.....	\$ 33.95	26.50

LABORERS CLASSIFICATIONS (UTILITY CONSTRUCTION)

GROUP 1: Construction laborer; Fence erector; Flagger; Grade checker; Guard rail erector; Wire mesh layer; Joint man (mortar, mastic and all other types); Lighting installer (permanent or temporary); Lineman for automatic grade maker on paving machines; Mortar man; Multi-plate erector; Rip-rap installer (all products and materials); Road marking and delineation laborer; Setting and placing of all precast concrete products; Sign installation including supporting structure; Spraying of all epoxy, curing compound, or like material; sod layer; Air tool, power tool, and power equipment operator; Asphalt lute man; Asphalt raker man; Batch truck dumper; Bridge handrail erector; Handler (bulk or bag cement); Chain saw man; concrete puddler; concrete rubber; Concrete saw operator; Core drill operator, eye level; Hand blade operator; Hydro seeder man; Motor-driven Georgia buggy operator; Power-driven compactor or tamper operator; Power saw operator; Pumpcrete assembly man; Screed man or screw man on asphalt paver; Rebar installer; Sandblaster man; Sealer applicator for asphalt (toxic); Setting and placing prestressed or precast concrete structural members; Side rail setter (for sidewalks, side ditches, radii, and pavements); Spreader box tender (manual or power-driven); Straw blower man; Subsurface drain and culvert pipe layer; Transverse and longitudinal hand bull float man; Concrete conveyor assembly man; Horizontal boring and jacking man; Jackman and sheetman; Pipe grade man; Winch and windlass operator

GROUP 2: Cutting torch burner; Laser beam aligner; Manhole erector; Sewer pipe layer; Water line installer, temporary or permanent; Welder (electric or oxy-acetylene) in connection with waterline and sewer work, Hod Carrier (tending bricklayers); TVing and associated grouting of utility lines

GROUP 3: Air track and wagon drillman; Concrete barrier rail form setter; Dynamite and powder man; General leadman; Concrete Saw Joint Control cutting

LAB00120-003 04/01/2024

UTILITY CONSTRUCTION

MARION & SHELBY COUNTIES

	Rates	Fringes
Laborers:		
GROUP 1.....	\$ 29.60	18.22
GROUP 2.....	\$ 30.10	18.22
GROUP 3.....	\$ 30.60	18.22

LABORERS CLASSIFICATIONS (UTILITY CONSTRUCTION)

GROUP 1: Construction laborer; Fence erector; Flagger; Grade checker; Guard rail erector; Wire mesh layer; Joint man (mortar, mastic and all other types); Lighting installer (permanent or temporary); Lineman for automatic grade maker on paving machines; Mortar man; Multi-plate erector; Rip-rap installer (all products and materials); Road marking and delineation laborer; Setting and placing of all precast concrete products; Sign installation including supporting structure; Spraying of all epoxy, curing compound, or like material; sod layer; Air tool, power tool, and power equipment operator; Asphalt lute man; Asphalt raker man; Batch truck dumper; Bridge handrail erector; Handler (bulk or bag cement); Chain saw man; concrete puddler; concrete rubber; Concrete saw operator; Core drill operator, eye level; Hand blade operator; Hydro seeder man; Motor-driven Georgia buggy operator; Power-driven compactor or tamper operator; Power saw operator; Pumpcrete assembly man; Screed man or screw man on asphalt paver; Rebar installer; Sandblaster man; Sealer applicator for asphalt (toxic); Setting and placing prestressed or precast concrete structural members; Side rail setter (for sidewalks, side ditches, radii, and pavements); Spreader box tender (manual or power-driven); Straw blower man; Subsurface drain and culvert pipe layer; Transverse and longitudinal hand bull float man; Concrete conveyor assembly man; Horizontal boring and jacking man; Jackman and sheetman; Pipe grade man; Winch and windlass operator

GROUP 2: Cutting torch burner; Laser beam aligner; Manhole erector; Sewer pipe layer; Water line installer, temporary or permanent; Welder (electric or oxy-acetylene) in connection with waterline and sewer work, TVing and associated grouting of utility lines

GROUP 3: Air track and wagon drillman; Concrete barrier rail form setter; Dynamite and powder man; General leadman; Concrete Saw Joint Control cutting; Hod Carrier (tending bricklayers)

LAB00204-003 04/01/2024

UTILITY CONSTRUCTION

CLAY, FOUNTAIN, GREENE, HENDRICKS, OWEN, PARKE, PUTNAM, SULLIVAN, VERMILLION, VIGO, & WARREN COUNTIES

	Rates	Fringes
Laborers:		
GROUP 1.....	\$ 29.60	18.22
GROUP 2.....	\$ 30.10	18.22
GROUP 3.....	\$ 30.60	18.22

LABORERS CLASSIFICATIONS (UTILITY CONSTRUCTION)

GROUP 1: Construction laborer; Fence erector; Flagger; Grade checker; Guard rail erector; Wire mesh layer; Joint man (mortar, mastic and all other types); Lighting installer (permanent or temporary); Lineman for automatic grade maker on paving machines; Mortar man; Multi-plate erector; Rip-rap installer (all products and materials); Road marking and delineation laborer; Setting and placing of all precast concrete products; Sign installation including supporting structure; Spraying of all epoxy, curing compound, or like material; sod layer; Air tool, power tool, and power equipment operator; Asphalt lute man; Asphalt raker man; Batch truck dumper; Bridge handrail erector; Handler (bulk or bag cement); Chain saw man; concrete puddler; concrete rubber; Concrete saw operator; Core drill operator, eye level; Hand blade operator; Hydro seeder man; Motor-driven Georgia buggy operator; Power-driven compactor or tamper operator; Power saw operator; Pumpcrete assembly man; Screed man or screw man on asphalt paver; Rebar installer; Sandblaster man; Sealer applicator for asphalt (toxic); Setting and placing prestressed or precast concrete structural members; Side rail setter (for sidewalks, side ditches, radii, and pavements); Spreader box tender (manual or power-driven); Straw blower man; Subsurface drain and culvert pipe layer; Transverse and longitudinal hand bull float man; Concrete conveyor assembly man; Horizontal boring and jacking man; Jackman and sheetman; Pipe grade man; Winch and windlass operator

GROUP 2: Cutting torch burner; Laser beam aligner; Manhole erector; Sewer pipe layer; Water line installer, temporary or permanent; Welder (electric or oxy-acetylene) in connection with waterline and sewer work, TVing and associated grouting of utility lines

GROUP 3: Air track and wagon drillman; Concrete barrier rail form setter; Dynamite and powder man; General leadman; Hod Carrier (tending bricklayers); Concrete Saw Joint Control cutting

LAB00213-003 04/01/2024

UTILITY CONSTRUCTION

ADAMS, ALLEN, DEKALB, HUNTINGTON, NOBLE, STEUBEN, WABASH, WELLS, & WHITLEY COUNTIES

	Rates	Fringes
Laborers:		
GROUP 1.....	\$ 29.60	18.22
GROUP 2.....	\$ 30.10	18.22
GROUP 3.....	\$ 30.60	18.22

LABORERS CLASSIFICATIONS (UTILITY CONSTRUCTION)

GROUP 1: Construction laborer; Fence erector; Flagger; Grade checker; Guard rail erector; Wire mesh layer; Joint man (mortar, mastic and all other types); Lighting installer (permanent or temporary); Lineman for automatic grade maker on paving machines; Mortar man; Multi-plate erector; Rip-rap installer (all products and materials); Road marking and delineation laborer; Setting and placing of all precast concrete products; Sign installation including supporting structure; Spraying of all epoxy, curing compound, or like material; sod layer; Air tool, power tool, and power equipment operator; Asphalt lute man; Asphalt raker man; Batch truck dumper; Bridge handrail erector; Handler (bulk or bag cement); Chain saw man; concrete puddler; concrete rubber; Concrete saw operator; Core drill operator, eye level; Hand blade operator; Hydro seeder man; Motor-driven Georgia buggy operator; Power-driven compactor or tamper operator; Power saw operator; Pumpcrete assembly man; Screed man or screw man on asphalt paver; Rebar installer; Sandblaster man; Sealer applicator for asphalt (toxic); Setting and placing prestressed or precast concrete structural members; Side rail setter (for sidewalks, side ditches, radii, and pavements); Spreader box tender (manual or power-driven); Straw blower man; Subsurface drain and culvert pipe layer; Transverse and longitudinal hand bull float man; Concrete conveyor assembly man; Horizontal boring and jacking man; Jackman and sheetman; Pipe grade man; Winch and windlass operator

GROUP 2: Cutting torch burner; Laser beam aligner; Manhole erector; Sewer pipe layer; Water line installer, temporary or permanent; Welder (electric or oxy-acetylene) in connection with waterline and sewer work, TVing and associated grouting of utility lines

GROUP 3: Air track and wagon drillman; Concrete barrier rail form setter; Dynamite and powder man; General leadman; Hod Carrier (tending bricklayers); Concrete Saw Joint Control cutting

LAB00274-005 04/01/2024

UTILITY CONSTRUCTION

BENTON, BOONE, CARROLL, CASS, CLINTON, FULTON, HOWARD, MIAMI, MONTGOMERY, PULASKI, TIPPECANOE, TIPTON, and WHITE COUNTIES

	Rates	Fringes
Laborers:		
GROUP 1.....	\$ 29.60	18.22
GROUP 2.....	\$ 30.10	18.22
GROUP 3.....	\$ 30.60	18.22

LABORERS CLASSIFICATIONS (UTILITY CONSTRUCTION)

GROUP 1: Construction laborer; Fence erector; Flagger; Grade checker; Guard rail erector; Wire mesh layer; Joint man (mortar, mastic and all other types); Lighting installer (permanent or temporary); Lineman for automatic grade maker

on paving machines; Mortar man; Multi-plate erector; Rip-rap installer (all products and materials); Road marking and delineation laborer; Setting and placing of all precast concrete products; Sign installation including supporting structure; Spraying of all epoxy, curing compound, or like material; sod layer; Air tool, power tool, and power equipment operator; Asphalt lute man; Asphalt raker man; Batch truck dumper; Bridge handrail erector; Handler (bulk or bag cement); Chain saw man; concrete puddler; concrete rubber; Concrete saw operator; Core drill operator, eye level; Hand blade operator; Hydro seeder man; Motor-driven Georgia buggy operator; Power-driven compactor or tamper operator; Power saw operator; Pumpcrete assembly man; Screed man or screw man on asphalt paver; Rebar installer; Sandblaster man; Sealer applicator for asphalt (toxic); Setting and placing prestressed or precast concrete structural members; Side rail setter (for sidewalks, side ditches, radii, and pavements); Spreader box tender (manual or power-driven); Straw blower man; Subsurface drain and culvert pipe layer; Transverse and longitudinal hand bull float man; Concrete conveyor assembly man; Horizontal boring and jacking man; Jackman and sheetman; Pipe grade man; Winch and windlass operator

GROUP 2: Cutting torch burner; Laser beam aligner; Manhole erector; Sewer pipe layer; Water line installer, temporary or permanent; Welder (electric or oxy-acetylene) in connection with waterline and sewer work, Tving and associated grouting of utility lines

GROUP 3: Air track and wagon drillman; Concrete barrier rail form setter; Dynamite and powder man; General leadman; Hod Carrier (tending bricklayers); Concrete Saw Joint Control cutting

 LAB00561-015 04/01/2024

UTILITY CONSTRUCTION

DAVISS, DUBOIS, GIBSON, KNOX, PIKE, POSEY, SPENCER, VANDERBURGH, & WARRICK COUNTIES

	Rates	Fringes
Laborers:		
GROUP 1.....	\$ 29.60	18.22
GROUP 2.....	\$ 30.10	18.22
GROUP 3.....	\$ 30.60	18.22

LABORERS CLASSIFICATIONS (UTILITY CONSTRUCTION)

GROUP 1: Construction laborer; Fence erector; Flagger; Grade checker; Guard rail erector; Wire mesh layer; Joint man (mortar, mastic and all other types); Lighting installer (permanent or temporary); Lineman for automatic grade maker on paving machines; Mortar man; Multi-plate erector; Rip-rap installer (all products and materials); Road marking and delineation laborer; Setting and placing of all precast concrete products; Sign installation including supporting structure; Spraying of all epoxy, curing compound, or like material; sod layer; Air tool, power tool, and power equipment operator; Asphalt lute man;

Asphalt raker man; Batch truck dumper; Bridge handrail erector; Handler (bulk or bag cement); Chain saw man; concrete puddler; concrete rubber; Concrete saw operator; Core drill operator, eye level; Hand blade operator; Hydro seeder man; Motor-driven Georgia buggy operator; Power-driven compactor or tamper operator; Power saw operator; Pumpcrete assembly man; Screed man or screw man on asphalt paver; Rebar installer; Sandblaster man; Sealer applicator for asphalt (toxic); Setting and placing prestressed or precast concrete structural members; Side rail setter (for sidewalks, side ditches, radii, and pavements); Spreader box tender (manual or power-driven); Straw blower man; Subsurface drain and culvert pipe layer; Transverse and longitudinal hand bull float man; Concrete conveyor assembly man; Horizontal boring and jacking man; Jackman and sheetman; Pipe grade man; Winch and windlass operator

GROUP 2: Cutting torch burner; Laser beam aligner; Manhole erector; Sewer pipe layer; Water line installer, temporary or permanent; Welder (electric or oxy-acetylene) in connection with waterline and sewer work, Hod Carrier (tending bricklayers); Tying and associated grouting of utility lines

GROUP 3: Air track and wagon drillman; Concrete barrier rail form setter; Dynamite and powder man; General leadman; Concrete Saw Joint Control cutting

LAB00645-005 04/01/2024

UTILITY CONSTRUCTION

ELKHART COUNTY

	Rates	Fringes
Laborers:		
GROUP 1.....	\$ 29.60	18.22
GROUP 2.....	\$ 30.10	18.22
GROUP 3.....	\$ 30.60	18.22

LABORERS CLASSIFICATIONS (UTILITY CONSTRUCTION)

GROUP 1: Construction laborer; Fence erector; Flagger; Grade checker; Guard rail erector; Wire mesh layer; Joint man (mortar, mastic and all other types); Lighting installer (permanent or temporary); Lineman for automatic grade maker on paving machines; Mortar man; Multi-plate erector; Rip-rap installer (all products and materials); Road marking and delineation laborer; Setting and placing of all precast concrete products; Sign installation including supporting structure; Spraying of all epoxy, curing compound, or like material; sod layer; Air tool, power tool, and power equipment operator; Asphalt lute man; Asphalt raker man; Batch truck dumper; Bridge handrail erector; Handler (bulk or bag cement); Chain saw man; concrete puddler; concrete rubber; Concrete saw operator; Core drill operator, eye level; Hand blade operator; Hydro seeder man; Motor-driven Georgia buggy operator; Power-driven compactor or tamper operator; Power saw operator; Pumpcrete assembly man; Screed man or screw man on asphalt paver; Rebar installer; Sandblaster man; Sealer applicator for asphalt (toxic); Setting and placing

prestressed or precast concrete structural members; Side rail setter (for sidewalks, side ditches, radii, and pavements); Spreader box tender (manual or power-driven); Straw blower man; Subsurface drain and culvert pipe layer; Transverse and longitudinal hand bull float man; Concrete conveyor assembly man; Horizontal boring and jacking man; Jackman and sheetman; Pipe grade man; Winch and windlass operator

GROUP 2: Cutting torch burner; Laser beam aligner; Manhole erector; Sewer pipe layer; Water line installer, temporary or permanent; Welder (electric or oxy-acetylene) in connection with waterline and sewer work, Hod Carrier (tending bricklayers); Tying and associated grouting of utility lines

GROUP 3: Air track and wagon drillman; Concrete barrier rail form setter; Dynamite and powder man; General leadman; Concrete Saw Joint Control cutting

 LAB00645-006 04/01/2024

UTILITY CONSTRUCTION

KOSCIUSKO, LAGRANGE, & MARSHALL COUNTIES

	Rates	Fringes
Laborers:		
GROUP 1.....	\$ 29.60	18.22
GROUP 2.....	\$ 30.10	18.22
GROUP 3.....	\$ 30.60	18.22

LABORERS CLASSIFICATIONS (UTILITY CONSTRUCTION)

GROUP 1: Construction laborer; Fence erector; Flagger; Grade checker; Guard rail erector; Wire mesh layer; Joint man (mortar, mastic and all other types); Lighting installer (permanent or temporary); Lineman for automatic grade maker on paving machines; Mortar man; Multi-plate erector; Rip-rap installer (all products and materials); Road marking and delineation laborer; Setting and placing of all precast concrete products; Sign installation including supporting structure; Spraying of all epoxy, curing compound, or like material; sod layer; Air tool, power tool, and power equipment operator; Asphalt lute man; Asphalt raker man; Batch truck dumper; Bridge handrail erector; Handler (bulk or bag cement); Chain saw man; concrete puddler; concrete rubber; Concrete saw operator; Core drill operator, eye level; Hand blade operator; Hydro seeder man; Motor-driven Georgia buggy operator; Power-driven compactor or tamper operator; Power saw operator; Pumpcrete assembly man; Screed man or screw man on asphalt paver; Rebar installer; Sandblaster man; Sealer applicator for asphalt (toxic); Setting and placing prestressed or precast concrete structural members; Side rail setter (for sidewalks, side ditches, radii, and pavements); Spreader box tender (manual or power-driven); Straw blower man; Subsurface drain and culvert pipe layer; Transverse and longitudinal hand bull float man; Concrete conveyor assembly man; Horizontal boring and jacking man; Jackman and sheetman; Pipe grade man; Winch and windlass operator

GROUP 2: Cutting torch burner; Laser beam aligner; Manhole erector; Sewer pipe layer; Water line installer, temporary or permanent; Welder (electric or oxy-acetylene) in connection with waterline and sewer work, Hod Carrier (tending bricklayers); TVing and associated grouting of utility lines

GROUP 3: Air track and wagon drillman; Concrete barrier rail form setter; Dynamite and powder man; General leadman; Concrete Saw Joint Control cutting

 LAB00741-007 04/01/2024

UTILITY CONSTRUCTION

BARTHOLOMEW, BROWN, DEARBORN, DECATUR, FRANKLIN, JACKSON, JENNINGS, JOHNSON, LAWRENCE, MARTIN, MONROE, MORGAN, OHIO, ORANGE & RIPLEY COUNTIES

	Rates	Fringes
Laborers:		
GROUP 1.....	\$ 29.60	18.22
GROUP 2.....	\$ 30.10	18.22
GROUP 3.....	\$ 30.60	18.22

LABORERS CLASSIFICATIONS (UTILITY CONSTRUCTION)

GROUP 1: Construction laborer; Fence erector; Flagger; Grade checker; Guard rail erector; Wire mesh layer; Joint man (mortar, mastic and all other types); Lighting installer (permanent or temporary); Lineman for automatic grade maker on paving machines; Mortar man; Multi-plate erector; Rip-rap installer (all products and materials); Road marking and delineation laborer; Setting and placing of all precast concrete products; Sign installation including supporting structure; Spraying of all epoxy, curing compound, or like material; sod layer; Air tool, power tool, and power equipment operator; Asphalt lute man; Asphalt raker man; Batch truck dumper; Bridge handrail erector; Handler (bulk or bag cement); Chain saw man; concrete puddler; concrete rubber; Concrete saw operator; Core drill operator, eye level; Hand blade operator; Hydro seeder man; Motor-driven Georgia buggy operator; Power-driven compactor or tamper operator; Power saw operator; Pumpcrete assembly man; Screed man or screw man on asphalt paver; Rebar installer; Sandblaster man; Sealer applicator for asphalt (toxic); Setting and placing prestressed or precast concrete structural members; Side rail setter (for sidewalks, side ditches, radii, and pavements); Spreader box tender (manual or power-driven); Straw blower man; Subsurface drain and culvert pipe layer; Transverse and longitudinal hand bull float man; Concrete conveyor assembly man; Horizontal boring and jacking man; Jackman and sheetman; Pipe grade man; Winch and windlass operator

GROUP 2: Cutting torch burner; Laser beam aligner; Manhole erector; Sewer pipe layer; Water line installer, temporary or permanent; Welder (electric or oxy-acetylene) in connection with waterline and sewer work, TVing and associated grouting of utility lines

GROUP 3: Air track and wagon drillman; Concrete barrier rail form setter; Dynamite and powder man; General leadman; Hod Carrier (tending bricklayers); Concrete Saw Joint Control cutting

LAB00795-004 04/01/2024

UTILITY CONSTRUCTION

CLARK, CRAWFORD, FLOYD, HARRISON, JEFFERSON, PERRY, SCOTT, SWITZERLAND, & WASHINGTON COUNTIES

	Rates	Fringes
Laborers:		
GROUP 1.....	\$ 29.60	18.22
GROUP 2.....	\$ 30.10	18.22
GROUP 3.....	\$ 30.60	18.22

LABORERS CLASSIFICATIONS (UTILITY CONSTRUCTION)

GROUP 1: Construction laborer; Fence erector; Flagger; Grade checker; Guard rail erector; Wire mesh layer; Joint man (mortar, mastic and all other types); Lighting installer (permanent or temporary); Lineman for automatic grade maker on paving machines; Mortar man; Multi-plate erector; Rip-rap installer (all products and materials); Road marking and delineation laborer; Setting and placing of all precast concrete products; Sign installation including supporting structure; Spraying of all epoxy, curing compound, or like material; sod layer; Air tool, power tool, and power equipment operator; Asphalt lute man; Asphalt raker man; Batch truck dumper; Bridge handrail erector; Handler (bulk or bag cement); Chain saw man; concrete puddler; concrete rubber; Concrete saw operator; Core drill operator, eye level; Hand blade operator; Hydro seeder man; Motor-driven Georgia buggy operator; Power-driven compactor or tamper operator; Power saw operator; Pumpcrete assembly man; Screed man or screw man on asphalt paver; Rebar installer; Sandblaster man; Sealer applicator for asphalt (toxic); Setting and placing prestressed or precast concrete structural members; Side rail setter (for sidewalks, side ditches, radii, and pavements); Spreader box tender (manual or power-driven); Straw blower man; Subsurface drain and culvert pipe layer; Transverse and longitudinal hand bull float man; Concrete conveyor assembly man; Horizontal boring and jacking man; Jackman and sheetman; Pipe grade man; Winch and windlass operator

GROUP 2: Cutting torch burner; Laser beam aligner; Manhole erector; Sewer pipe layer; Water line installer, temporary or permanent; Welder (electric or oxy-acetylene) in connection with waterline and sewer work, Hod Carrier (tending bricklayers); TVing and associated grouting of utility lines

GROUP 3: Air track and wagon drillman; Concrete barrier rail form setter; Dynamite and powder man; General leadman; Concrete Saw Joint Control cutting

LAB00999-001 04/01/2023

HEAVY AND HIGHWAY CONSTRUCTION

ALL COUNTIES EXCEPT: Jasper, Newton, & Starke

	Rates	Fringes
Laborers:		
GROUP 1.....	\$ 28.50	17.72
GROUP 2.....	\$ 29.00	17.72
GROUP 3.....	\$ 29.50	17.72

LABORERS CLASSIFICATIONS

GROUP 1: Construction laborer; Fence erector; Flagger; Grade checker; Guard rail erector; Wire mesh layer; Joint man (mortar, mastic and all other types); Lighting installer (permanent or temporary); Lineman for automatic grade maker on paving machines; Mortar man; Multi-plate erector; Rip-rap installer (all products and materials); Road marking and delineation laborer; Setting and placing of all precast concrete products; Sign installation including supporting structure; Spraying of all epoxy, curing compound, or like material; sod layer; Air tool, power tool, and power equipment operator; Asphalt lute man; Asphalt raker man; Batch truck dumper; Bridge handrail erector; Handler (bulk or bag cement); Chain saw man; concrete puddler; concrete rubber; Concrete saw operator; Core drill operator, eye level; Hand blade operator; Hydro seeder man; Motor-driven Georgia buggy operator; Power-driven compactor or tamper operator; Power saw operator; Pumpcrete assembly man; Screed man or screw man on asphalt paver; Rebar installer; Sandblaster man; Sealer applicator for asphalt (toxic); Setting and placing prestressed or precast concrete structural members; Side rail setter (for sidewalks, side ditches, radii, and pavements); Spreader box tender (manual or power-driven); Straw blower man; Subsurface drain and culvert pipe layer; Transverse and longitudinal hand bull float man; Concrete conveyor assembly man; Horizontal boring and jacking man; Jackman and sheetman; Pipe grade man; Winch and windlass operator

GROUP 2: Cutting torch burner; Laser beam aligner; Manhole erector; Sewer pipe layer; Water line installer, temporary or permanent; Welder (electric or oxy-acetylene) in connection with waterline and sewer work, Tving and associated grouting of utility lines

GROUP 3: Air track and wagon drillman; Concrete barrier rail form setter; Dynamite and powder man; General leadman; Hod Carrier (tending bricklayers); Concrete Saw Joint Control cutting

 LAB01112-003 04/01/2024

UTILITY CONSTRUCTION

BLACKFORD, DELAWARE, FAYETTE, GRANT, HAMILTON, HANCOCK, HENRY, JAY, MADISON, RANDOLPH, RUSH, UNION & WAYNE COUNTIES

Rates	Fringes
-------	---------

Laborers:

GROUP 1.....	\$ 29.10	18.22
GROUP 2.....	\$ 30.10	18.22
GROUP 3.....	\$ 30.60	18.22

LABORERS CLASSIFICATIONS (UTILITY CONSTRUCTION)

GROUP 1: Construction laborer; Fence erector; Flagger; Grade checker; Guard rail erector; Wire mesh layer; Joint man (mortar, mastic and all other types); Lighting installer (permanent or temporary); Lineman for automatic grade maker on paving machines; Mortar man; Multi-plate erector; Rip-rap installer (all products and materials); Road marking and delineation laborer; Setting and placing of all precast concrete products; Sign installation including supporting structure; Spraying of all epoxy, curing compound, or like material; sod layer; Air tool, power tool, and power equipment operator; Asphalt lute man; Asphalt raker man; Batch truck dumper; Bridge handrail erector; Handler (bulk or bag cement); Chain saw man; concrete puddler; concrete rubber; Concrete saw operator; Core drill operator, eye level; Hand blade operator; Hydro seeder man; Motor-driven Georgia buggy operator; Power-driven compactor or tamper operator; Power saw operator; Pumpcrete assembly man; Screed man or screw man on asphalt paver; Rebar installer; Sandblaster man; Sealer applicator for asphalt (toxic); Setting and placing prestressed or precast concrete structural members; Side rail setter (for sidewalks, side ditches, radii, and pavements); Spreader box tender (manual or power-driven); Straw blower man; Subsurface drain and culvert pipe layer; Transverse and longitudinal hand bull float man; Concrete conveyor assembly man; Horizontal boring and jacking man; Jackman and sheetman; Pipe grade man; Winch and windlass operator

GROUP 2: Cutting torch burner; Laser beam aligner; Manhole erector; Sewer pipe layer; Water line installer, temporary or permanent; Welder (electric or oxy-acetylene) in connection with waterline and sewer work, Tving and associated grouting of utility lines

GROUP 3: Air track and wagon drillman; Concrete barrier rail form setter; Dynamite and powder man; Hod Carrier (tending bricklayers); General leadman; Concrete Saw Joint Control cutting

 PAIN0012-006 05/01/2024

COMMERCIAL AND INDUSTRIAL

DEARBORN, OHIO, RIPLEY AND SWITZERLAND COUNTIES:

	Rates	Fringes
PAINTER		
Bridges, Lead Abatement.....	\$ 31.68	14.46
Brush & Roller,		
Paperhanger, Drywall Taping.	\$ 30.34	14.46
Sandblasting, Waterblasting.	\$ 31.68	14.46
Spray.....	\$ 28.79	14.46

 PAIN0027-005 06/01/2024

NEWTON COUNTY, West of Highway #41

	Rates	Fringes
GLAZIER.....	\$ 51.55	43.99

 PAIN0047-005 06/01/2024

BARTHOLOMEW, BOONE, BROWN, DECATUR, HAMILTON, HANCOCK,
 HENDRICKS, JACKSON, JENNINGS, JOHNSON, LAWRENCE, MARION,
 MARTIN, MONROE, MORGAN, ORANGE, AND SHELBY COUNTIES

	Rates	Fringes
PAINTER		
BRIDGE WORK		
Concrete/Masonry Bridges...	\$ 26.44	13.30
Steel Bridges.....	\$ 30.50	14.50
NON-BRIDGE WORK		
Brush, Roller.....	\$ 31.02	16.89
Spray and Sand-Blasting....	\$ 30.52	15.89

 PAIN0080-001 06/01/2024

BENTON, CARROLL, CASS, CLINTON, FOUNTAIN, MONTGOMERY TIPPECANOE
 AND WARREN COUNTIES

	Rates	Fringes
PAINTER		
Brush and Roller.....	\$ 30.00	17.96
Spray and Sandblasting.....	\$ 30.95	17.96

 PAIN0091-007 06/01/2024

ELKHART, FULTON, KOSCIUSKO AND MARSHALL COUNTIES

	Rates	Fringes
PAINTER		
Brush & Roller, Drywall		
Taping & Finishing,		
Vinyl/Paper Hanging.....	\$ 31.00	18.62
Spray.....	\$ 31.50	18.62

 PAIN0118-005 06/01/2024

CLARK, CRAWFORD, FLOYD, HARRISON JEFFERSON, SCOTT AND
 WASHINGTON COUNTIES

	Rates	Fringes
Painters:		
Heavy Construction		
Brush, Roller &		
Paperhanger.....	\$ 22.20	14.07
Spray, Sandblast &		
Waterblast.....	\$ 23.45	13.19
Highway Construction &		
Railroad Bridges		
Brush, Roller &		
Paperhanger.....	\$ 36.30	15.85

Spray, Sandblast &
Waterblast.....\$ 36.30 15.85

PAIN0156-001 04/01/2024

DAVISS, DUBOIS, GIBZSON, KNOX, PERRY, PIKE, POSSEY, SPENCER,
VANDERBURGH, AND WARRICK COUNTIES

Rates Fringes

Painters:

BRUSH & ROLLER OF MASTICS, CREOSOTES, KEWINCH KOATE, & COAL TAR EPOXY.....\$ 30.62	19.32
BRUSH & ROLLER.....\$ 29.62	19.32
DRYWALL FINISHERS.....\$ 30.37	19.32
SPRAY of MASTICS CREOSOTES, KWINCH KOATE, COAL TAR EPOXY.....\$ 30.62	19.32
SPRAY, SANDBLAST, POWER TOOLS, WATERBLAST & STEAM CLEANING.....\$ 30.62	19.32

FOOTNOTE A:

All Structures over 40? \$0.75/ hour above base wage
All Structures over 75? \$1.50/ hour above base wage
All Structures over 100? \$2.50/ hour above base wage

PAIN0197-001 06/01/2024

CLAY, GREENE, OWEN, PARKE, PUTNAM, SULLIVAN, VERMILLION AND
VIGO COUNTIES:

Rates Fringes

Painters:

Brush & Roller.....\$ 30.25	15.50
Sandblasting.....\$ 32.25	15.50
Spray & Pot Man.....\$ 30.75	15.50

FOOTNOTE A: \$1.00 premium for work on structures over 40 ft.
 above floor/ground level
 \$2.00 premium for work on structures over 100 ft
 above floor/ground level

PAIN0387-004 11/01/2023

DEARBORN, FRANKLIN, OHIO, RIPLEY, and SWITZERLAND COUNTIES

Rates Fringes

GLAZIER.....\$ 31.95	17.75
----------------------	-------

PAIN0460-004 06/01/2024

JASPER, NEWTON, PULASKI, STARKE AND WHITE COUNTIES

Rates Fringes

Painters:

Brush & Roller

Building.....	\$ 39.00	30.96
Brush and Roller		
Heavy and Highway.....	\$ 39.00	30.96
Drywall Taping & Finishing..	\$ 39.80	30.96

PAIN0469-002 06/01/2023

ADAMS, ALLEN, DEKALB, GRANT, HUNTINGTON, LAGRANGE, NOBLE,
STEUBEN, WABASH, WELLS, and WHITLEY COUNTIES

	Rates	Fringes
--	-------	---------

Painters:

Brush, Roller, Paperhanger, & Drywall Finishing.....	\$ 25.04	15.32
Lead Abatement.....	\$ 30.24	15.32
Spray & Sandblast Pot Tenders and Ground Personnel.....	\$ 25.05	15.32
Spray, Sandblast, Power Tools, Waterblast, & Steam Cleaning.....	\$ 25.04	15.32

PAIN0669-001 05/01/2024

BLACKFORD, DELAWARE, FAYETTE, FRANKLIN, HENRY, HOWARD, JAY,
MADISON, MIAMI, RANDOLPH, RUSH, TIPTON, UNION and WAYNE COUNTIES

	Rates	Fringes
--	-------	---------

Painters:

Brush; Roller; Paperhanging; Drywall Finishers.....	\$ 25.10	16.39
Spray/Waterblasting; Sandblasting.....	\$ 26.10	16.39

PAIN1165-014 07/01/2024

CLARK, CRAWFORD, DAVIESS, DUBOIS, FLOYD, GIBSON, HARRISION,
JEFFERSON, KNOX, MARTIN, ORANGE, PERRY, PIKE, POSEY, SCOTT,
SPENCER, VANDERBURGH, WARRICK AND WASHINGTON

	Rates	Fringes
--	-------	---------

GLAZIER.....	\$ 32.86	19.34
--------------	----------	-------

PAIN1165-017 07/01/2024

ADAMS, ALLEN, BLACKFORD, DE KALB, GRANT, HUNTINGTON, JAY,
NOBLE, STEUBEN, WABASH, WELLS AND WHITLEY COUNTIES

	Rates	Fringes
--	-------	---------

GLAZIER.....	\$ 28.75	18.72
--------------	----------	-------

PAIN1165-018 07/01/2023

JASPER and NEWTON (East of Highway #41) COUNTIES

	Rates	Fringes
GLAZIER.....	\$ 40.09	27.98

PAIN1165-019 07/01/2024		

ELKHART, FULTON, KOSCIUSKO, LAGRANGE, MARSHALL, PULASKI, and STARKE COUNTY

	Rates	Fringes
GLAZIER.....	\$ 32.22	23.57

PAIN1165-022 01/01/2024		

BARTHOLOMEW, BENTON, BOONE, BROWN, CARROLL, CASS, CLAY, CLINTON, DECATUR, DELEWARE, FAYETTE, FOUNTAIN, GREENE, HAMILTON, HANCOCK, HENDRICKS, HENRY, HOWARD, JACKSON, JENNINGS, JOHNSON, LAWRENCE, MADISON, MARION, MIAMI, MONROE, MONTGOMERY, MORGAN, OWEN, PARKE, PUTNAM, RANDOLPH, RUSH, SHELBY, SULLIVAN, TIPPECANOE, TIPTON, UNION, VIGO, VERMILLION, WARREN, WAYNE, and WHITE COUNTIES

	Rates	Fringes
GLAZIER.....	\$ 34.03	20.05

PLAS0075-001 06/01/2017		

CLAY, OWEN, PARKE, PUTNAM, VERMILLION AND VIGO COUNTIES:

	Rates	Fringes
CEMENT MASON/CONCRETE FINISHER...	\$ 25.75	13.50

PLAS0075-002 06/01/2017		

GREENE and SULLIVAN COUNTIES

	Rates	Fringes
CEMENT MASON/CONCRETE FINISHER...	\$ 28.50	13.50

PLAS0101-001 06/01/2018		

ELKHART, FULTON AND MARSHALL COUNTIES; PULASKI COUNTY (SOUTHERN 1/2):

	Rates	Fringes
CEMENT MASON/CONCRETE FINISHER...	\$ 31.50	14.30

PLAS0101-008 06/01/2014		

ADAMS, ALLEN, DEKALB, HUNTINGTON, KOSCIUSKO, LAGRANGE, NOBLE, STEUBEN, WELLS AND WHITLEY COUNTIES

	Rates	Fringes
CEMENT MASON/CONCRETE FINISHER...	\$ 23.38	11.94
PLASTERER.....	\$ 25.69	11.75

PLAS0438-003 06/01/2018

PULASKI (NORTHERN 2/3), JASPER (N. EASTERN PORTION OF WEST TO BUT NOT INCLUDING WHEATFIELD), ALL OF STARKE COUNTY

	Rates	Fringes
CEMENT MASON/CONCRETE FINISHER...	\$ 36.01	25.40

PLAS0692-002 06/01/2024

AREA #46

BARTHOLOMEW, BOONE, BROWN, CLARK, CLAY, CRAWFORD, DAVIESS, DUBOIS, GIBSON, HENDRICKS, JACKSON, JEFFERSON, JENNINGS, JOHNSON, KNOX, LAWRENCE, MARION, MARTIN, MONROE, MORGAN, ORANGE, OWEN, PARKE, PERRY, PIKE, POSEY, PUTNAM, SCOTT, SHELBY, SPENCER, VANDERBURGH, VERMILLION, VIGO and WARRICK COUNTIES

	Rates	Fringes
PLASTERER.....	\$ 30.50	17.62

PLAS0692-008 05/01/2024

BARTHOLOMEW, BROWN, CLARK, DEARBORN, FLOYD, JACKSON, JEFFERSON, JENNINGS, LAWRENCE, OHIO, ORANGE, RIPLEY, SCOTT, SHELBY, SWITZERLAND, and WASHINGTON Counties

	Rates	Fringes
CEMENT MASON/CONCRETE FINISHER AREA #821.....	\$ 29.02	17.60

PLAS0692-009 06/01/2024

AREA #83

BLACKFORD, DELAWARE, GRANT, HAMILTON (Northern Part), HANCOCK (Northern Part), JAY, MADISON, TIPTON, and WABASH COUNTIES

	Rates	Fringes
CEMENT MASON/CONCRETE FINISHER...	\$ 31.25	20.34
PLASTERER.....	\$ 29.99	16.60

PLAS0692-011 06/01/2024

AREA #83

DECATUR, FAYETTE, FRANKLIN, HENRY, RANDOLPH, RUSH, UNION and WAYNE COUNTIES

	Rates	Fringes
CEMENT MASON/CONCRETE FINISHER...	\$ 31.25	20.34
PLASTERER.....	\$ 29.99	16.60

PLAS0692-015 06/01/2024

AREA #121

BENTON, CARROLL, CASS, CLINTON, FOUNTAIN, HOWARD, MIAMI, MONTGOMERY, TIPPECANOE, WARREN, WHITE and VERMILLION (Northern Part) COUNTIES

	Rates	Fringes
CEMENT MASON/CONCRETE FINISHER...	\$ 31.25	20.20
PLASTERER.....	\$ 33.76	20.05

PLAS0692-018 06/01/2024		

AREA #165

NEWTON COUNTIES

	Rates	Fringes
CEMENT MASON/CONCRETE FINISHER...	\$ 39.74	24.05

PLAS0692-022 06/01/2024		

Southward on Rt. No. 49 to the JASPER, BENTON and WHITE County lines, including the City Limits of Wheatfield, Rensselaer and Remington, Indiana. To the West, the boundary of NEWTON County

	Rates	Fringes
CEMENT MASON/CONCRETE FINISHER AREA #406.....	\$ 38.50	25.29

PLAS0692-023 06/01/2024		

AREA #532

BOONE, HAMILTON (SOUTH HALF OF COUNTY NORTH TO NEW ROUTE INDIANA #32 INCLUDING NOBLESVILLE); HANCOCK COUNTY (SOUTHERN AND WESTERN PART OF HANCOCK COUNTY, NORTH TO BUT NOT INCLUDING FORTVILLE); HENDRICKS, JOHNSON, MARION and MORGAN COUNTIES

	Rates	Fringes
CEMENT MASON/CONCRETE FINISHER...	\$ 33.15	20.06
Slip Form Shift Work.....	\$ 33.00	19.56
Swinging/Suspended Scaffold.	\$ 32.25	19.56

PLAS0692-027 04/01/2024		

AREA #566

CRAWFORD, DAVIESS, DUBOIS, GIBSON, HARRISON, KNOX, MARTIN, PERRY, PIKE, POSEY, SPENCER, VANDERBURGH and WARRICK COUNTIES

	Rates	Fringes
CEMENT MASON/CONCRETE FINISHER...	\$ 31.25	19.71

PLUM0136-003 04/01/2024		

BROWN, DAVIESS, DUBOIS, GIBSON, JACKSON, LAWRENCE, MARTIN,
MONROE, ORANGE, OWEN, PERRY, PIKE, POSEY, SPENCER, VANDERBURGH,
WARRICK, and WASHINGTON Counties

	Rates	Fringes
Plumbers and Pipefitters.....	\$ 43.67	21.35

PLUM0157-002 01/01/2025		

BENTON, CARROLL, CLINTON, FOUNTAIN, MONTGOMERY, TIPPECANOE,
WARREN AND WHITE COUNTIES:

	Rates	Fringes
Plumbers and Pipefitters.....	\$ 45.45	22.50

PLUM0166-001 06/01/2024		

ADAMS, ALLEN, BLACKFORD, DE KALB, GRANT, HUNTINGTON, NOBLE,
STEUBEN, WABASH, WELLS, and WHITLEY COUNTIES

	Rates	Fringes
Plumber and Steamfitter.....	\$ 41.50	21.66

PLUM0166-002 06/01/2024		

ELKHART, KOSCIUSKO, and LAGRANGE COUNTIES

	Rates	Fringes
PLUMBER.....	\$ 41.50	21.66

PLUM0172-001 06/01/2024		

JASPER (S of the N. Side of the City of Rensselaer), MARSHALL,
PULASKI and STARKE COUNTIES

	Rates	Fringes
Plumber, Pipefitter, Steamfitter.....	\$ 40.78	23.09

PLUM0210-003 09/01/2024		

JASPER (to the City of Rensselaer) and NEWTON COUNTIES

	Rates	Fringes
PLUMBER.....	\$ 47.52	28.41

PLUM0392-006 06/01/2024		

DEARBORN, OHIO, RIPLEY, AND SWITZERLAND COUNTIES

	Rates	Fringes
Plumbers and Pipefitters.....	\$ 40.70	29.52

PLUM0440-002 06/04/2024		

BARTHOLOMEW, BOONE, HAMILTON, HANCOCK, HENDRICKS, HOWARD,
 JOHNSON AND MARION COUNTIES; MIAMI COUNTY (SOUTH OF A STRAIGHT
 LINE WHERE ROUTE 218 ENTERS W. BOUNDARY); MORGAN, SHELBY and
 TIPTON COUNTIES

	Rates	Fringes
Plumbers and Pipefitters.....	\$ 46.50	19.89

PLUM0440-004 06/01/2024		

FAYETTE, FRANKLIN, HENRY, RANDOLPH, RUSH, UNION and WAYNE
 COUNTIES

	Rates	Fringes
Plumber and Steamfitter.....	\$ 46.50	19.89

PLUM0502-001 08/01/2016		

CLARK, FLOYD AND HARRISON COUNTIES

	Rates	Fringes
PLUMBER/PIPEFITTER.....	\$ 32.00	20.13

PLUM0597-004 06/01/2018		

JASPER (Excluding the city limits of Rensselear), AND NEWTON
 (Entire County)

	Rates	Fringes
PIPEFITTER.....	\$ 48.50	31.12

ROOF0023-004 06/01/2024		

ADAMS, ALLEN, DEKALB, ELKHART, FULTON, HUNTINGTON, KOSCIUSKO,
 LAGRANGE, MARSHALL, MIAMI, NOBLE, PULASKI, STARKE, STEUBEN,
 WABASH, WELLS, and WHITLEY COUNTIES

	Rates	Fringes
ROOFER		
COMPOSITION.....	\$ 34.55	21.04
SLATE & TILE.....	\$ 36.05	21.04

ROOF0026-002 06/01/2023		

JASPER AND NEWTON COUNTIES

	Rates	Fringes
ROOFER.....	\$ 42.50	25.76

ROOF0042-002 08/01/2024		

DEARBORN, OHIO and RIPLEY COUNTIES

Rates	Fringes
-------	---------

ROOFER.....\$ 33.00 19.51

ROOF0075-001 05/01/2024

FAYETTE, RANDOLPH, UNION, and WAYNE Counties

Rates Fringes

ROOFER
Composition.....\$ 28.73 20.81
Slate & Tile.....\$ 28.95 20.81

ROOF0075-002 05/01/2021

CLINTON COUNTY

Rates Fringes

ROOFER
Composition.....\$ 24.38 20.09
Slate & Tile.....\$ 24.60 20.09

ROOF0106-006 04/01/2023

CRAWFORD, DAVIESS, DUBOIS, GIBSON KNOX, MARTIN, ORANGE PERRY,
PIKE, POSEY, SPENCER, VANDERBURGH AND WARRICK

Rates Fringes

ROOFER
COMPOSITION.....\$ 31.60 19.43
SLATE & TILE.....\$ 31.60 19.43

ROOF0106-012 07/01/2024

CLARK, FLOYD, HARRISON JEFFERSON, SCOTT, SWITZERLAND, and
WASHINGTON Counties

Rates Fringes

ROOFER.....\$ 30.25 13.71

ROOF0119-002 09/01/2024

BARTHOLOMEW, BLACKFORD, BOONE, BROWN, DECATUR, DELAWARE,
FRANKLIN, GRANT, HAMILTON, HANCOCK, HENDRICKS, HENRY, HOWARD,
JACKSON, JAY, JENNINGS, JOHNSON, LAWRENCE, MADISON, MARION,
MONROE, MONTGOMERY, MORGAN, PUTNAM, RUSH, SHELBY, and TIPTON
Counties

Rates Fringes

ROOFER.....\$ 31.00 14.21

ROOF0150-002 07/01/2024

CLAY, GREENE, OWEN, PARKE, SULLIVAN, VERMILLION AND VIGO
COUNTIES

Rates Fringes

ROOFER.....\$ 30.00 18.30

SHEE0020-003 07/01/2023

Rates Fringes

Sheet metal worker (HVAC Duct
Work).....\$ 34.58 29.98

SHEE0020-010 07/01/2023

BARTHOLOMEW, BOONE, BROWN, DECATUR, DELAWARE, FAYETTE,
FRANKLIN, HAMILTON, HANCOCK, HENDRICKS, HENRY, JACKSON,
JENNINGS, JOHNSON, LAWRENCE, MADISON, MARION, MONROE,
MONTGOMERY, MORGAN, ORANGE, RIPLEY, RUSH, SHELBY, TIPTON, UNION
AND WASHINGTON COUNTIES

Rates Fringes

SHEET METAL WORKER.....\$ 40.91 25.22

SHEE0020-011 07/01/2023

CLINTON COUNTY

Rates Fringes

SHEET METAL WORKER.....\$ 37.82 26.37

SHEE0020-024 07/01/2023

CLAY, GREENE, MARTIN, OWEN, PARKE, PUTNAM, SULLIVAN,
VERMILLION, and VIGO COUNTIES

Rates Fringes

Sheet metal worker.....\$ 40.91 25.22

TEAM0135-003 04/01/2024

REMAINING COUNTIES

Rates Fringes

TRUCK DRIVER

GROUP 1.....\$ 33.86 19.74
GROUP 2.....\$ 33.91 19.74
GROUP 3.....\$ 33.96 19.74
GROUP 4.....\$ 34.01 19.74
GROUP 5.....\$ 34.06 19.74
GROUP 6.....\$ 34.11 19.74
GROUP 7.....\$ 34.16 19.74
GROUP 8.....\$ 34.21 19.74
GROUP 9.....\$ 34.26 19.74
GROUP10.....\$ 33.71 19.74
GROUP11.....\$ 34.26 19.74
GROUP12.....\$ 34.36 19.74

TRUCK DRIVER CLASSIFICATIONS

GROUP 1: Single/batches axle straight trucks; Batch trucks,
wet or dry 3 (34E) axle or less; Single axle Grease and

maintenance truck

GROUP 2: Single axle fuel and water trucks

GROUP 3: Single axle "dog-legs", and tandem truck or dog-legs; Winch trucks or A-frames when used for transportation purposes; Drivers on batch trucks, wet or dry over 3 (34E) batches and tandem axle grease and maintenance truck

GROUP 4: Tandem axle fuel trucks; tandem axle water trucks; butuminous distributors (two-man)

GROUP 5: Tandem trucks over 15 tons payload; Single axle semi trucks; Farm tractors hauling material; Mixer trucks (all types); Trucks pulling tilt-top trailer single axle; Single axle low- boys; Truck-mounted pavement breakers

GROUP 6: Tandem trucks or "dog-legs"; Semi-water Truck; Sprinkler Truck; Heavy equipment-type water wagons, 5,000 gallons and under; butuminous distributors (one-man)

GROUP 7: Tri-axle trucks; Tandem axle semi trucks; Equipment when not self-loaded or pusher loaded, such as Koehring or similar dumpsters, track trucks, Euclid bottom dump and hug bottom dump, tournatrailers, tournarockers, Acey wagons or for similar equipment (12 cu yds or less); Mobile mixer truck; Tandem Axle trucks pulling tilt-top trailer; Tandem - Axle lowboy; Tri- Axle batch Truck; Tri-Axle grease and maintenance truck

GROUP 8: Tandem-tandem semi trucks; Truck mechanics and welders; Heavy equipment-type water wagon over 5,000 gallons; Tri-Axle Trucks pulling tilt-top trailer; Low-boys, tandem-tandem axle

GROUP 9: Low-boys, tandem tri-axle; Acey wagons up to and including 3 buckets; Equipment when not self-loaded or pusher loaded, such as koehring or similar dumpsters, Track Trucks, Euclid bottom dump and hug bottom dump, Tournatrailers, Tournarockers, Acey wagons or for similar equipment (over 12 cu yds.)

GROUP 10: Pick-up trucks

GROUP 11: Helpers; Greasers; Tire men; Batch board tenders; Warehouseman

GROUP 12: Acey wagon (over 3 buckets); Quad Axle Trucks; Articulating Dump

WELDERS - Receive rate prescribed for craft performing operation to which welding is incidental.

=====
Note: Executive Order (EO) 13706, Establishing Paid Sick Leave for Federal Contractors applies to all contracts subject to the Davis-Bacon Act for which the contract is awarded (and any solicitation was issued) on or after January 1, 2017. If this contract is covered by the EO, the contractor must provide employees with 1 hour of paid sick leave for every 30 hours they work, up to 56 hours of paid sick leave each year. Employees must be permitted to use paid sick leave for their

own illness, injury or other health-related needs, including preventive care; to assist a family member (or person who is like family to the employee) who is ill, injured, or has other health-related needs, including preventive care; or for reasons resulting from, or to assist a family member (or person who is like family to the employee) who is a victim of, domestic violence, sexual assault, or stalking. Additional information on contractor requirements and worker protections under the EO is available at <https://www.dol.gov/agencies/whd/government-contracts>.

Unlisted classifications needed for work not included within the scope of the classifications listed may be added after award only as provided in the labor standards contract clauses (29CFR 5.5 (a) (1) (iii)).

The body of each wage determination lists the classifications and wage rates that have been found to be prevailing for the type(s) of construction and geographic area covered by the wage determination. The classifications are listed in alphabetical order under rate identifiers indicating whether the particular rate is a union rate (current union negotiated rate), a survey rate, a weighted union average rate, a state adopted rate, or a supplemental classification rate.

Union Rate Identifiers

A four-letter identifier beginning with characters other than ""SU"", ""UAVG"", ?SA?, or ?SC? denotes that a union rate was prevailing for that classification in the survey. Example: PLUM0198-005 07/01/2024. PLUM is an identifier of the union whose collectively bargained rate prevailed in the survey for this classification, which in this example would be Plumbers. 0198 indicates the local union number or district council number where applicable, i.e., Plumbers Local 0198. The next number, 005 in the example, is an internal number used in processing the wage determination. The date, 07/01/2024 in the example, is the effective date of the most current negotiated rate.

Union prevailing wage rates are updated to reflect all changes over time that are reported to WHD in the rates in the collective bargaining agreement (CBA) governing the classification.

Union Average Rate Identifiers

The UAVG identifier indicates that no single rate prevailed for those classifications, but that 100% of the data reported for the classifications reflected union rates. EXAMPLE: UAVG-OH-0010 01/01/2024. UAVG indicates that the rate is a weighted union average rate. OH indicates the State of Ohio. The next number, 0010 in the example, is an internal number used in producing the wage determination. The date, 01/01/2024 in the example, indicates the date the wage determination was updated to reflect the most current union average rate.

A UAVG rate will be updated once a year, usually in January, to reflect a weighted average of the current rates in the collective bargaining agreements on which the rate is based.

Survey Rate Identifiers

The ""SU"" identifier indicates that either a single non-union rate prevailed (as defined in 29 CFR 1.2) for this classification in the survey or that the rate was derived by computing a weighted average rate based on all the rates reported in the survey for that classification. As a weighted average rate includes all rates reported in the survey, it may include both union and non-union rates. Example: SUFL2022-007 6/27/2024. SU indicates the rate is a single non-union prevailing rate or a weighted average of survey data for that classification. FL indicates the State of Florida. 2022 is the year of the survey on which these classifications and rates are based. The next number, 007 in the example, is an internal number used in producing the wage determination. The date, 6/27/2024 in the example, indicates the survey completion date for the classifications and rates under that identifier.

?SU? wage rates typically remain in effect until a new survey is conducted. However, the Wage and Hour Division (WHD) has the discretion to update such rates under 29 CFR 1.6(c)(1).

State Adopted Rate Identifiers

The ""SA"" identifier indicates that the classifications and prevailing wage rates set by a state (or local) government were adopted under 29 C.F.R 1.3(g)-(h). Example: SAME2023-007 01/03/2024. SA reflects that the rates are state adopted. ME refers to the State of Maine. 2023 is the year during which the state completed the survey on which the listed classifications and rates are based. The next number, 007 in the example, is an internal number used in producing the wage determination. The date, 01/03/2024 in the example, reflects the date on which the classifications and rates under the ?SA? identifier took effect under state law in the state from which the rates were adopted.

WAGE DETERMINATION APPEALS PROCESS

1) Has there been an initial decision in the matter? This can be:

- a) a survey underlying a wage determination
- b) an existing published wage determination
- c) an initial WHD letter setting forth a position on a wage determination matter
- d) an initial conformance (additional classification and rate) determination

On survey related matters, initial contact, including requests for summaries of surveys, should be directed to the WHD Branch of Wage Surveys. Requests can be submitted via email to davisbaconinfo@dol.gov or by mail to:

Branch of Wage Surveys
Wage and Hour Division
U.S. Department of Labor
200 Constitution Avenue, N.W.
Washington, DC 20210

Regarding any other wage determination matter such as conformance decisions, requests for initial decisions should be directed to the WHD Branch of Construction Wage Determinations. Requests can be submitted via email to BCWD-Office@dol.gov or

by mail to:

Branch of Construction Wage Determinations
Wage and Hour Division
U.S. Department of Labor
200 Constitution Avenue, N.W.
Washington, DC 20210

2) If an initial decision has been issued, then any interested party (those affected by the action) that disagrees with the decision can request review and reconsideration from the Wage and Hour Administrator (See 29 CFR Part 1.8 and 29 CFR Part 7). Requests for review and reconsideration can be submitted via email to dba.reconsideration@dol.gov or by mail to:

Wage and Hour Administrator
U.S. Department of Labor
200 Constitution Avenue, N.W.
Washington, DC 20210

The request should be accompanied by a full statement of the interested party's position and any information (wage payment data, project description, area practice material, etc.) that the requestor considers relevant to the issue.

3) If the decision of the Administrator is not favorable, an interested party may appeal directly to the Administrative Review Board (formerly the Wage Appeals Board). Write to:

Administrative Review Board
U.S. Department of Labor
200 Constitution Avenue, N.W.
Washington, DC 20210.

=====

END OF GENERAL DECISION"